

# MY LIFE WITH O<sub>3</sub>, NO<sub>x</sub> AND OTHER YZO<sub>x</sub>s

Nobel Lecture, December 8, 1995

by

PAUL CRUTZEN

Max-Planck-Institute for Chemistry, Department of Atmospheric Chemistry,  
Mainz, Germany.

*To the generation of Jamie Paul and our future grandchildren, who will know so much more and who will celebrate the disappearance of the ozone hole. I hope you will not be disappointed with us.*

I was born in Amsterdam on December, 3, 1933, the son of Anna Gurk and Jozef Crutzen. I have one sister who still lives in Amsterdam with her family. My mother's parents moved to the industrial Ruhr region in Germany from East Prussia towards the end of the last century. They were of mixed German and Polish origin. In 1929 at the age of 17, my mother moved to Amsterdam to work as a housekeeper. There she met my father. He came from Vaals, a little town in the southeastern corner of the Netherlands, bordering Belgium and Germany and very close to the historical German city of Aachen. He died in 1977. He had relatives in the Netherlands, Germany and Belgium. Thus, from both parents I inherited a cosmopolitan view of the world. My mother, now 84 years old, still lives in Amsterdam, mentally very alert, but since a few months ago, wheelchair-bound. Despite having worked in several countries outside The Netherlands since 1958, I have remained a Dutch citizen.

In May, 1940, The Netherlands were overrun by the German army. In September of the same year I entered elementary school, "de grote school" (the big school), as it was popularly called. My six years of elementary school largely overlapped with the 2nd World War. Our school class had to move between different premises in Amsterdam after the German army had confiscated our original school building. The last months of the war, between the fall of 1944 and Liberation Day on May, 5, 1945, were particularly horrible. During the cold "hongerwinter" (winter of famine) of 1944-1945, there was a severe lack of food and heating fuels. Also water for drinking, cooking and washing was available only in limited quantities for a few hours per day, causing poor hygienic conditions. Many died of hunger and disease, including several of my schoolmates. Some relief came at the beginning of 1945 when the Swedish Red Cross dropped food supplies on parachutes from airplanes. To welcome them we waved our red, white and blue Dutch flags in the streets. I had of course not the slightest idea how important Sweden would become later in my life. We only had a few hours of school

each week, but because of special help from one of the teachers, I was allowed together with two other schoolmates to continue to the next and final class of elementary school; unfortunately, all the others lost a year. More or less normal school education only became possible again with the start of the new school year in the fall of 1945.

In 1946, after a successful entrance exam, I entered the "Hogere Burgerschool" (HBS), "Higher Citizen School", a 5 year long middle school, which prepared for University entrance. I finished this school in June, 1951, with natural sciences as my focal subjects. However, we all also had to become proficient in 3 foreign languages: French, English and German. I got considerable help in learning languages from my parents: German from my mother, French from my father. During those years, chemistry definitely was not one of my favourite subjects. They were mathematics and physics, but I also did very well in the three foreign languages. During my school years I spent considerable time with a variety of sports: football, bicycling, and my greatest passion, long distance skating on the Dutch canals and lakes. I also played chess, which in the Netherlands is ranked as a "denksport" (thought sport). I read widely about travels in distant lands, about astronomy, as well as about bridges and tunnels. Unfortunately, because of a heavy fever, my grades in the final exam of the HBS were not good enough to qualify for a university study stipend, which was very hard to obtain at that time, only 6 years after the end of the 2nd world war and a few years after the end of colonial war in Indonesia, which had been a large drain on Dutch resources. As I did not want to be a further financial burden on my parents for another 4 years or more (my father, a waiter, was often unemployed; my mother worked in the kitchen of a hospital), I chose to attend the Middelbare Technische School (MTS), middle technical school, now called the higher technical school (HTS), to train as a civil engineer. Although the MTS took 3 years, the second year was a practical year during which I earned a modest salary, enough to live on for about 2 years. From the summer of 1954 until February, 1958, with a 21-month interruption for compulsory military service in The Netherlands, I worked at the Bridge Construction Bureau of the City of Amsterdam. In the meanwhile, on a vacation trip in Switzerland, I met a sweet girl, Terttu Soininen, a student of Finnish history and literature at the University of Helsinki. A few years later I was able to entice her to marry me. What a great choice I made! She has been the center of a happy family; without her support, I would never have been able to devote so much of my time to studies and science. After our marriage in February, 1958, we settled in Gävle, a little town about 200 km north of Stockholm, where I had found a job in a building construction bureau. In December of that same year our daughter Ilona was born. In March, 1964, she got a little sister, Sylvia. Ilona is a registered nurse, now living in Boulder, Colorado. Her son Jamie Paul is 12 years old. Sylvia is a 'marketing assistant in München, Germany. All were present in Stockholm, Upsala and Gävle during the Nobel week. We had a happy and unforgettable time.

All this time I had longed for an academic career. One day, at the beginning of 1958, I saw an advertisement in a Swedish newspaper from the Department of Meteorology of Stockholm Högskola (from 1961, Stockholm University) announcing an opening for a computer programmer. Although I had not the slightest experience in this subject, I applied for the job and had the great luck to be chosen from among many candidates. On July 1, 1959, we moved to Stockholm and I started with my second profession. At that time the Meteorology Institute of Stockholm University (MISU) and the associated International Meteorological Institute (IMI) were at the forefront of meteorological research and many top researchers worked in Stockholm for extended periods. Only about a year earlier the founder of the institutes, Prof. Gustav Rossby, one of the greatest meteorologists ever, had died suddenly and was succeeded by Dr. Bert Bolin, another famous meteorologist, now "retired" as director of the Intergovernmental Panel on Climate Change (IPCC). At that time Stockholm University housed the fastest computers in the world (BESK and its successor FACIT).

With the exception of participation in a field campaign in northern Sweden, led by Dr. Georg Witt to measure the properties of noctilucent clouds, which appear during summer at about 85 km altitude in the coldest parts of atmosphere, and some programming work related to this, I was until about 1966 mainly involved in various meteorological projects, especially helping to build and run some of the first numerical (barotropic) weather prediction models. I also programmed a model of a tropical cyclone for a good friend, Hilding Sundquist, now a professor at MISU. At that time programming was a special art. Advanced general computer languages, such as Algol or Fortran, had not been developed, so that all programmes had to be written in specific machine code. One also had to make sure that all operations yielded numbers in the range  $-1 \leq x < 1$ , which meant that one had to scale all equations to stay within these limits; otherwise the computations would yield wrong results.

The great advantage of being at a university department was that I got the opportunity to follow some of the lecture courses that were offered at the university. By 1963 I could thus fulfill the requirement for the filosofie kandidat (corresponding to a Master of Science) degree, combining the subjects mathematics, mathematical statistics, and meteorology. Unfortunately; I could include neither physics nor chemistry in my formal education, because this would have required my participation in time consuming laboratory exercises. In this way I became a pure theoretician. I have, however, always felt close to experimental work, which I have strongly supported during my later years as director of research at the National Center of Atmospheric Research (NCAR) in Boulder, Colorado (1977-1980) and at the Max-Planck-Institute for Chemistry in Mainz, Germany (since 1980).

Being employed at the meteorological research institute, it was quite natural to take a meteorological topic for my filosofie licentiat thesis (comparable to a Ph.D. thesis). Building on my earlier experience further develop-

ment of a numerical model of a tropical cyclone had been proposed to me. However, around 1965 I was given the task of helping a scientist from the U.S. to develop a numerical model of the oxygen allotrope distribution in the stratosphere, mesosphere and lower thermosphere. This project got me highly interested in the photochemistry of atmospheric ozone and I started an intensive study of the scientific literature. This gave me an understanding of the status of scientific knowledge about stratospheric chemistry by the latter half of the 1960's, thus setting the "initial conditions" for my scientific career. Instead of the initially proposed research project, I preferred research on stratospheric chemistry, which was generously accepted. At that time the main topics of research at the Meteorological Institute at the University of Stockholm were dynamics, cloud physics, the carbon cycle, studies of the chemical composition of rainwater, and especially the "acid rain" problem which was largely "discovered" at MISU through the work of Svante Oden and Erik Eriksson. Several researchers at MISU, among them Prof. Bolin and my good friend and fellow student Henning Rodhe, now Professor in Chemical Meteorology at MISU, got heavily involved in the issue which drew considerable political interest at the first United Nation Conference on the Environment in Stockholm in 1972 (1). However, I wanted to do pure science related to natural processes and therefore I picked stratospheric ozone as my subject, without the slightest anticipation of what lay ahead. In this choice of research topic I was left totally free. I can not overstate how I value the generosity and confidence which were conveyed to me by my supervisors Prof. Georg Witt, an expert on the aeronomy of the upper atmosphere, and the head of MISU Prof. Bert Bolin. They were always extremely helpful and showed great interest in the progress of my research.

## STRATOSPHERIC OZONE CHEMISTRY

As early as 1930 the famous British scientist Sydney Chapman [2] had proposed that the formation of "odd oxygen",  $O_x = O + O_3$ , is due to photolysis of  $O_2$  by solar radiation at wavelengths shorter than 240 nm

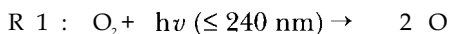

Rapid reactions, R2 and R3, next lead to the establishment of a steady state relationship between the concentrations of O and  $O_3$

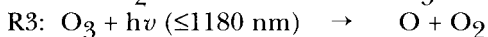

without affecting the concentration of odd oxygen. Destruction of odd oxygen, counteracting its production by reaction R1, occurs via the reaction



Until about the middle of the 1960's it was generally believed that reactions R1-R4 sufficed to explain the ozone concentration distribution in the stratosphere. However, by the mid 1960's, especially following a study by Benson and Axworthy (3), it became clear that reaction R4 is much too slow to balance the production of "odd oxygen" by reaction R1 (see Figure 1). In 1950 David Bates and Marcel Nicolet (4), together with Sydney Chapman the great pioneers of upper atmospheric photochemistry research, proposed

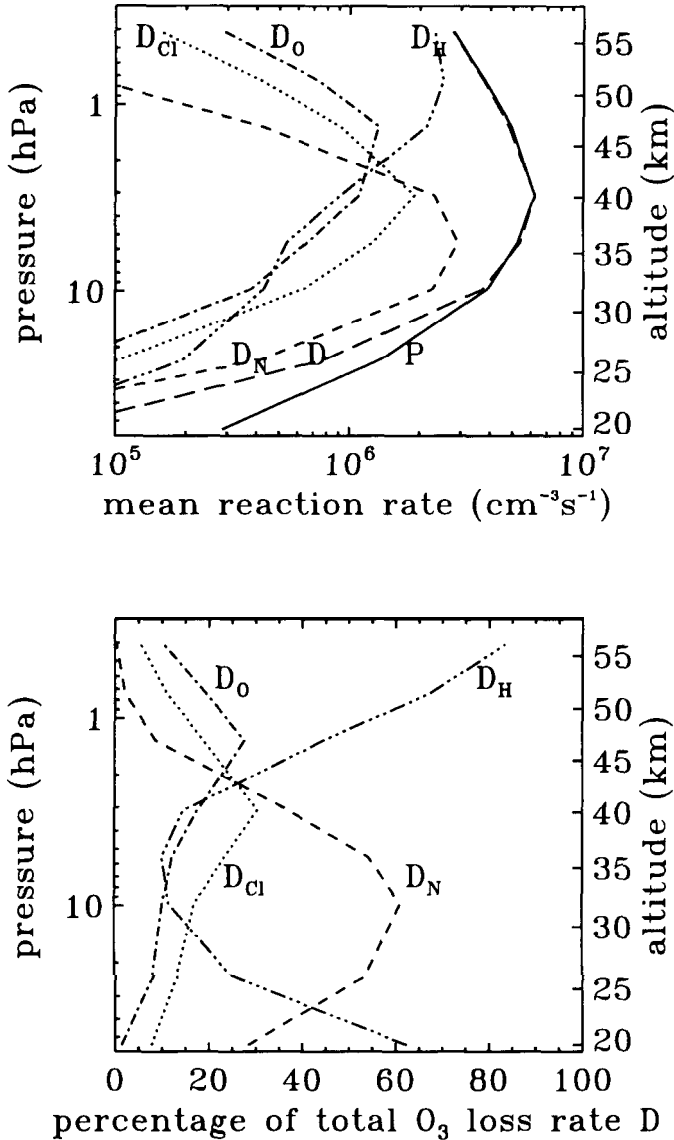
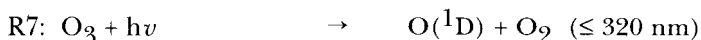

Figure 1: Ozone production and destruction rates, including absolute and relative contributions by the Chapman reaction R4 ( $D_{\text{O}}$ ),  $\text{NO}_x$  catalysis R11 + R12 ( $D_{\text{N}}$ ),  $\text{NO}$  catalysis R5 + R6 ( $D_{\text{H}}$ ) and  $\text{ClO}_x$  catalysis R21 + R22 ( $D_{\text{Cl}}$ ). (120). The calculations neglect the heterogeneous halogen activation which become very important below 25 km under cold conditions.

that catalytic reactions involving OH and HO<sub>2</sub> radicals could counterbalance the production of odd oxygen in the mesosphere and thermosphere. Building on their work and on laboratory studies conducted by one of the 1967 Nobel Prize Laureates in Chemistry, Prof. R. Norrish of Cambridge University and his coworkers (5, 6), the ozone destruction reaction pair (R5, R6) involving OH and HO<sub>2</sub> radicals as catalysts were postulated by Hampson (7) and incorporated in an atmospheric chemical model by Hunt (8):



The proposed primary source for the OH radicals was photolysis of O<sub>3</sub> by solar ultraviolet radiation of wavelengths shorter than about 320 nm, leading to electronically excited O(<sup>1</sup>D) atoms,



a small fraction of which reacts with water vapour



Most O(<sup>1</sup>D) reacts with O<sub>2</sub> and N<sub>2</sub> to rapidly reproduce O<sub>3</sub>, leading to a null cycle with no effect on ozone or odd oxygen



In the absence of laboratory measurements for the rate constants of reactions R5 and R6, and in order for these reactions to counterbalance the production of odd oxygen by reaction R1, Hunt adopted the rate constants

$$\begin{array}{l} k_5 = 5 \times 10^{-13} \text{ cm}^3 \text{ molec}^{-1} \text{ s}^{-1} \\ k_6 = 10^{-14} \text{ cm}^3 \text{ molec}^{-1} \text{ s}^{-1}. \end{array}$$

In my filosofie licentiat thesis of 1968 I analyzed the proposal by Hampson and Hunt and concluded that the rate constants for reactions R5 and R6 which they had chosen could not explain the vertical distribution of ozone in the photochemically dominated stratosphere above 25 km. Furthermore, I pointed out (9) that the above choice of rate constants would also lead to unrealistically rapid loss of ozone (on a timescale of only a few days) in the troposphere. Anticipating a possible role of OH in tropospheric chemistry, in the same study I also briefly mentioned the potential importance of a reaction between OH with CH<sub>4</sub>. We now know that reactions R5 and R6 proceed about 25 and 10 times slower, respectively, than postulated by Hunt and

Hampson and that the  $\text{CH}_4$  oxidation cycle plays a very large role in tropospheric chemistry, a topic to which we will return.

Regarding stratospheric ozone chemistry, I discarded the theory of Hampson and Hunt and concluded: "... at least part of the solution of the problem of the ozone distribution might be the introduction of photochemical processes other than those treated here. The influence of nitrogen compounds on the photochemistry of the ozone layer should be investigated".

Unfortunately no measurements of stratospheric  $\text{NO}_x$  ( $\text{NO}$  and  $\text{NO}_2$ ) were available to confirm my thoughts about their potential role in stratospheric chemistry. By the summer of 1969 I had joined the Department of Atmospheric Physics at the Clarendon Laboratory of Oxford University as a postdoctoral fellow of the European Space Research Organization and stayed there for a two year period. The head of the research group, Dr. (now Sir) John Houghton, hearing of my idea on the potential role of  $\text{NO}_x$ , handed me a solar spectrum, taken on board a balloon by Dr. David Murcray and coworkers of the University of Denver, and indicated to me that it might reveal the presence of  $\text{HNO}_3$  (10). After some analysis I could derive the approximate amounts of stratospheric  $\text{HNO}_3$ , including a rough idea of its vertical distributions. I did not get the opportunity to write up the result, because at about the same time, Rhine et al (11) published a paper, showing a vertical  $\text{HNO}_3$  column density of  $2.8 \times 10^{-4} \text{ atm.cm}$  ( $\approx 7.6 \times 10^{13} \text{ molecules cm}^{-2}$ ) above 18.8 km. With this information I knew that  $\text{NO}_x$  should also be present in the stratosphere as a result of the reactions,



This gave me enough confidence to submit my paper (12) on catalytic ozone destruction by  $\text{NO}$  and  $\text{NO}_2$ , based on the simple catalytic set of reactions:



The net result of reactions R11 and R12 is equivalent to the direct reaction R4. However, the rate of the net reaction can be greatly enhanced by relatively small quantities of  $\text{NO}_x$  on the order of a few nanomole/mole (or ppbv). I also included a calculation of the vertical distribution of stratospheric  $\text{HNO}_3$ . As the source of stratospheric  $\text{NO}_x$ , I initially accepted the proposal by Bates and Hays (13) that about 20% of the photolysis of  $\text{N}_2\text{O}$  would yield  $\text{N}$  and  $\text{NO}$ . Subsequent work showed that this reaction does not take place. However, it was soon shown that  $\text{NO}$  could also be formed to a lesser extent, but still in significant quantities, via the oxidation of nitrous oxide ( $\text{N}_2\text{O}$ )

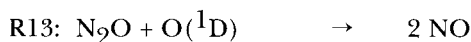

(14-16). It was further shown by Davis et al. (17) that reaction R12 proceeds about 3.5 times faster than I had originally assumed based on earlier laboratory work. Later it was also shown that earlier estimates of  $\text{O}_3$  production by reactions R1 and R2 had been too large due to overestimations of both the absorption cross sections of molecular oxygen (18) and solar intensities in the ozone producing 200-240 nm wavelength region (19, 20). As a result of these developments it became clear that enough NO is produced via reaction R13 to make reactions R11 and R12 the most important ozone loss reactions in the stratosphere in the altitude region between about 25 and 45 km.

$\text{N}_2\text{O}$  is a natural product of microbiological processes in soils and waters. A number of anthropogenic activities, such as the application of nitrogen fertilizers in agriculture, also lead to significant  $\text{N}_2\text{O}$  emissions. The rate of increase in atmospheric  $\text{N}_2\text{O}$  concentrations for the past decades has been about 0.3% per year (21). That, however, was not known in 1971. The discovery of the indirect role of a primarily biospheric product on the chemistry of the ozone layer has greatly stimulated interest in bringing biologists and atmospheric scientists together. Other examples of such biosphere-stratosphere interactions are  $\text{CH}_4$  and OCS.

#### MAN'S IMPACT ON STRATOSPHERIC OZONE

In the fall of 1970, still in Oxford, I obtained a preprint of a MIT sponsored Study on Critical Environmental Problems (SCEP) which was held in July of that year (22). This report also considered the potential impact of the introduction of large stratospheric fleets of supersonic aircraft (U.S.: Boeing; Britain/France: Concorde; Soviet Union: Tupolev) and gave me the first quantitative information on the stratospheric inputs of  $\text{NO}_x$  which would result from these operations. By comparing these with the production of  $\text{NO}_x$  by reaction R13, I realized immediately that we could be faced with a severe global environmental problem. Although the paper in which I proposed the important catalytic role of  $\text{NO}_x$  on ozone destruction had already been published in April, 1970, clearly the participants in the study conference had not taken any note of it, since they concluded "The direct role of CO,  $\text{CO}_2$ , NO,  $\text{NO}_2$ ,  $\text{SO}_2$ , and hydrocarbons in altering the heat budget is small. It is also unlikely that their involvement in ozone photochemistry is as significant as water vapour". I was quite upset by that statement. Somewhere in the margin of this text I wrote "Idiots".

After it became quite clear to me that I had stumbled on a hot topic, I decided to extend my 1970 study by treating in much more detail the chemistry of the oxides of nitrogen ( $\text{NO}$ ,  $\text{NO}_2$ ,  $\text{NO}_3$ ,  $\text{N}_2\text{O}_4$ ,  $\text{N}_2\text{O}_5$ ), hydrogen ( $\text{OH}$ ,  $\text{HO}_2$ ), and  $\text{HNO}_3$ , partially building on a literature review by Nicolet (23). I soon got into big difficulties. In the first place, adopting Nicolet's reaction scheme I calculated high concentrations of  $\text{N}_2\text{O}_4$ , a problem which



I could soon resolve when I realized that this compound is thermally unstable, a fact which was not considered by Nicolet. A greater headache was caused by the supposedly gas phase reactions



and



for which the only laboratory studies available at that time had yielded rather high rate coefficients:  $k_{14} = 1.7 \times 10^{-18} \text{ cm}^3 \text{ molec}^{-1} \text{ s}^{-1}$  and  $k_{15} = 1.7 \cdot 10^{-17} \times 10^{-11} \text{ cm}^3 \text{ molec}^{-1} \text{ s}^{-1}$  at room temperatures. A combination of reactions R14 and R15 with these rate constants would provide a very large source of OH radicals, about a thousand times larger than supplied by reaction R8, leading to prohibitively rapid catalytic ozone loss. This was a terribly nervous period for me. At that time no critical reviews and recommendations of rate coefficients were available. With no formal background in chemistry, I basically had to compile and comprehend much of the needed chemistry by myself from the available publications, although I profited greatly from discussions with colleagues at the University of Oxford, especially Dr. Richard Wayne of the Physical Chemistry Laboratory, a former student of Prof. R. Norrish in Cambridge. I discussed all these difficulties and produced extensive model calculations on the vertical distributions of trace gases in the  $\text{O}_x\text{-NO}_x\text{-HO}_x\text{-HNO}_x$  system in a paper which was submitted by the end of 1970 to the Journal of Geophysical Research (received January 13, 1971) and which, after revision, was finally published in the October 20 issue of 1971 (15). The publication of this paper was much delayed because of an extended mail strike in Britain. Because of the major problems I had encountered, I did not make any calculations of ozone depletions, but instead drew attention to the potential seriousness of the problem by stating "An artificial increase of the mixing ratio of the oxides of nitrogen in the stratosphere by about  $1 \times 10^8$  may lead to observable changes in the atmospheric ozone level" and further in the text "It is estimated that global nitrogen oxide mixing ratios may increase by almost  $10^8$  from a fleet of 500 SSTs in the stratosphere. Larger increases, up to  $7 \times 10^8$ , are possible in regions of high traffic densities .... Clearly, serious decreases in the total atmospheric ozone level and changes in the vertical distributions of ozone, at least in certain regions, can result from such an activity..."

#### THE SUPERSONIC TRANSPORT CONTROVERSY IN THE U.S.

Unknown to me, a debate on the potential environmental impact of supersonic stratospheric transport (SST) had erupted in the U.S. Initially the concern was mainly enhanced catalytic ozone destruction by OH and  $\text{HO}_2$  radi-

cals resulting from the release of H<sub>2</sub>O in the engine exhausts (24). By mid-March, 1971, a workshop was organized in Boulder, Colorado, by an Advisory Board of the Department of Commerce, to which Prof. Harold Johnston of the University of California, Berkeley, was invited. As an expert in laboratory kinetics and reaction mechanisms of NO<sub>x</sub> compounds (e.g. 25-27), he immediately realized that the role of NO<sub>x</sub> in reducing stratospheric ozone had been grossly underestimated. Very quickly (submission 14 April, revision 14 June) on August 6, 1971, his paper appeared in *Science* (27) with the title "Reduction of Stratospheric Ozone by Nitrogen Oxide Catalysts from Supersonic Transport Exhaust". In the abstract of this paper Johnston stated "... oxides of nitrogen from SST exhaust pose a much greater threat to the ozone layer than does the increase in water. The projected increase in stratospheric oxides of nitrogen could reduce the ozone shield by about a factor of 2, thus permitting the harsh radiation below 300 nanometers to permeate the lower atmosphere". During the summer of 1971, I received a preprint of Johnston's study via a representative of British Aerospace, one of the Concorde manufacturers. This was the first time I had heard of Harold Johnston, for whom I quickly developed a great respect both as a scientist and a human being. Although I had expressed myself rather modestly about the potential impact of stratospheric NO<sub>x</sub> emissions from SST's, for the reasons given above, I fully agreed with Prof. Johnston on the potential severe consequences for stratospheric ozone and I was really happy to have support for my own ideas from such an eminent scientist. For a thorough resume of the controversies between scientists and industry, and between meteorologists and chemists, recurring themes also in later years, I refer to Johnston's article "Atmospheric Ozone" (28). It should also be mentioned here that Prof. Johnston's publications in the early 1970's removed several of the major reaction kinetic problems which I had encountered in my 1971 study (15). It was shown, for instance, that neither reaction R14 nor R15 occur to a significant degree in the gas phase, and that the earlier laboratory studies had been strongly influenced by reactions on the walls of the reaction vessels (29), an advice which was earlier also given to me in a private communication by Prof. Sydney Benson of the University of Southern California.

In July, 1971, I returned to the University of Stockholm and devoted myself mainly to studies concerning the impact of NO<sub>x</sub> releases from SST's on stratospheric ozone. In May, 1973, I submitted my inaugural dissertation "On the Photochemistry of Ozone in the Stratosphere and Troposphere and Pollution of the Stratosphere by High-Flying Aircraft" to the Faculty of Natural Sciences and was awarded the degree of Doctor of Philosophy with the highest possible distinction, the third time this had ever happened during the history of Stockholm University (and earlier Stockholm "Högskola"). This was one of the last occasions in which the classical and rather solemn "Filosofie Doktor", similar to the Habilitation in Germany and France, was awarded. I had to dress up just like during the Nobel Ceremonies. First and second "opponents" were Dr. John Houghton and Dr.

Richard Wayne of the University of Oxford, who wore their college gowns for the occasion. Dr. Wayne also served as a most capable, not obligatory, third opponent, whose task it was to make a fool of the candidate. Unfortunately, the classical doctoral degree has been abolished (I was one of the last ones to go through the procedure). The modern Swedish Filosofie Doktor degree corresponds more closely to the former Filosofie Licential degree.

In large part as a result of the proposal by Johnston (27) that  $\text{NO}_x$  emissions from SST's could severely harm the ozone layer, major research programs were started, the Climate Impact Assessment Program (CLAP), organized by the U.S. Department of Transportation (30), and the COVOS/COMESA (31, 32) program, jointly sponsored by France and Great Britain (the producers of the Concorde Aircraft). The aim of these programs was to study the chemical and meteorological processes that determine the abundance and distribution of ozone in the stratosphere, about which so little was known that the stratosphere was sometimes dubbed the "ignorosphere". The outcome of the CIAP study was summarized in a publication by the U.S. National Academy of Sciences in 1975 (33). "We recommend that national and international regulatory authorities be alerted to the existence of potentially serious problems arising from growth of future fleets of stratospheric airlines, both subsonic and supersonic. The most clearly established problem is a potential reduction of ozone in the stratosphere, leading to an increase in biologically harmful ultraviolet light at ground level".

The proposed large fleets of SST's never materialized, largely for economic reasons; only a few Concorde are currently in operation. The CLAP and COVOS/COMESA research program, however, greatly enhanced knowledge about stratospheric chemistry. They confirmed the catalytic role of  $\text{NO}_x$  in stratospheric ozone chemistry. A convincing example of this was provided by a major solar proton event which occurred in August, 1972 and during which, within a few hours, large quantities of NO, comparable to the normal  $\text{NO}_x$  content, were produced at high geomagnetic latitudes ( $> 65^\circ$ ), as shown in Figure 2. With such a large input of NO, a clear depletion of stratospheric ozone was expected (34), a hypothesis which was confirmed by

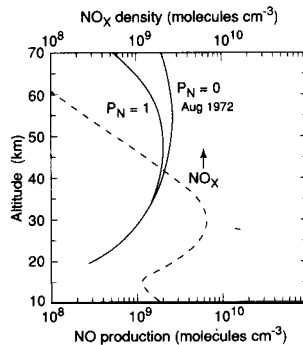

Figure 2: Production of NO at high geomagnetic latitudes during the solar proton event of 1972 for two assumptions about the electronic states of the N atoms formed ( $P_N = 0$ , or 1). Also shown are the average  $\text{NO}_x$  concentrations for these locations.

analysis of satellite observations (35). Figure 3 shows results of the calculated and observed ozone depletions, the former obtained with a model which also considered chlorine chemistry (36).

Although I had started my scientific career with the ambition to do basic research related to natural processes, the experiences of the early 1970's had made it utterly clear to me that human activities had grown so much that they could compete and interfere with natural processes. Since then this has been an important factor in my research efforts. Already by the end of 1971 I wrote in an article published in the "The Future of Science Year Book" of the USSR in 1972:

"... the upper atmosphere is an important part of our environment. Let us finish by expressing a sincere hope that in the future environmental dangers

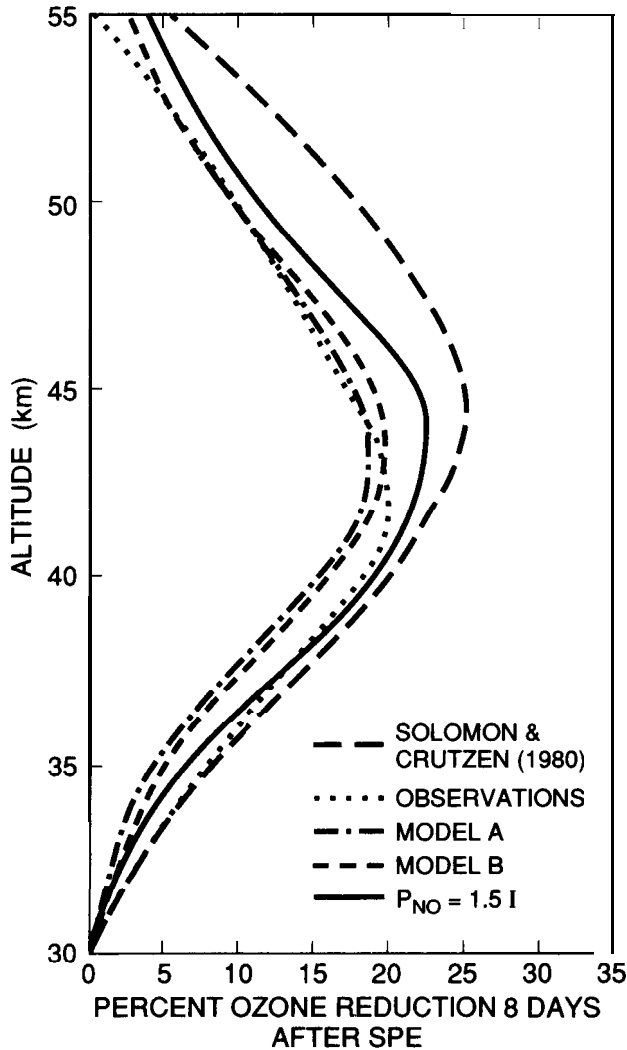

Figure 3: Observed and calculated percentage ozone depletions resulting from the 1972 solar proton event. The various calculated curves correspond to assumed values of parameters that were not well known.

of new technological development will be recognizable at an early stage. The proposed supersonic air transport is an example of a potential threat to the environment by future human activities. Other serious problems will certainly arise in the increasingly complicated world of tomorrow".

### *Tropospheric Ozone*

My first thoughts on tropospheric ozone photochemistry go back to 1968, as discussed briefly above (9). However, in the following 3 years, my research was largely devoted to stratospheric ozone chemistry. Then in 1971 a very important paper with the title "Normal Atmosphere: Large Radical and Formaldehyde Concentrations Predicted" was published by Hiram Levy III, then of the Smithsonian Astrophysical Observatory in Cambridge, Massachusetts (37). Levy proposed that OH radicals could also be produced in the troposphere by the action of solar ultraviolet radiation on ozone (Reaction R8), and that they are responsible for the oxidation of CH<sub>4</sub> and CO, an idea which was also quickly adopted by Jack McConnell, Michael McElroy and Steve Wofsy (38) of Harvard University. The recognition of the important role of OH was a major step forward in our understanding of atmospheric chemistry. Despite very low atmospheric concentrations, currently estimated at 10<sup>6</sup> molecules/cm<sup>3</sup>, corresponding to a mean tropospheric volume mixing ratio of 4 × 10<sup>-14</sup> (39), it is this ultramajor constituent - and not the 10<sup>13</sup> times more abundant O<sub>3</sub> - which is responsible for the oxidation of almost all compounds that are emitted into the atmosphere by natural processes and anthropogenic activities. The lifetimes of most atmospheric gases are, therefore, largely determined by the concentrations of OH and the corresponding reaction coefficients (40) (see Table 1). Those gases

**Table 1:** Schematic representation of importance of OH radicals in atmospheric chemistry.

#### PRIMARY PRODUCTION OF OH RADICALS

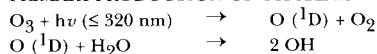

GLOBAL, 24 HOUR, AVERAGE (OH) = 10<sup>6</sup> MOLECULES/CM<sup>3</sup>

MOLAR MIXING RATIO IN TROPOSPHERE ≈ 4 × 10<sup>-14</sup>

#### REACTION WITH OH DETERMINES THE LIFETIME OF MOST GASES IN ATMOSPHERE

##### EXAMPLES:

|                                    |           |
|------------------------------------|-----------|
| CH <sub>4</sub> :                  | 8 YEARS   |
| C <sub>2</sub> H <sub>6</sub> :    | 2 MONTHS  |
| C <sub>3</sub> H <sub>8</sub> :    | 10 DAYS   |
| C <sub>5</sub> H <sub>8</sub> :    | HOURS     |
| (CH <sub>3</sub> ) <sub>2</sub> S: | 2-3 DAYS  |
| CH <sub>3</sub> Cl:                | ≈ 1 YEAR  |
| CH <sub>3</sub> CCl <sub>3</sub> : | ≈ 5 YEARS |
| NO <sub>2</sub> :                  | ≈ 1 DAY   |

CFCl<sub>3</sub>, CF<sub>2</sub>Cl<sub>2</sub>, N<sub>2</sub>O do not react with OH. They are broken down in the stratosphere and have a large influence on ozone chemistry.

that do not react with OH have very long atmospheric residence times and are largely destroyed in the stratosphere. Examples of the latter class of compounds are  $N_2O$ , and several fully halogenated, industrial organic compounds, such as  $CFCl_3$ ,  $CF_2Cl_2$ , and  $CCl_4$ . These play a major role in stratospheric ozone chemistry, an issue to which we will return.

Following Levy's paper my attention returned strongly to tropospheric chemistry. Starting with a presentation at the 1972 International Ozone Symposium in Davos, Switzerland, I proposed that *in situ* chemical processes could produce or destroy ozone in quantities larger than the estimated downward flux of ozone from the stratosphere to the troposphere (41, 42). Destruction of ozone occurs via reactions R7 + R8 and R5 + R6. Ozone production takes place in environments containing sufficient  $NO_x$ , via

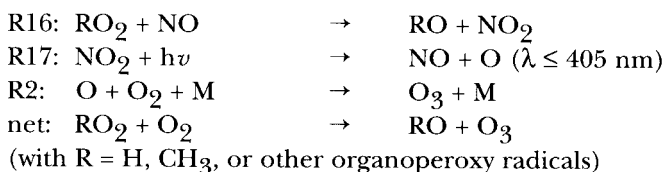

The catalytic role of NO in atmospheric chemistry is, therefore, twofold. At altitudes above about 25 km, where O atom concentrations are high, ozone destruction by reactions R11 + R12 dominates over ozone production by reactions R16 + R17 + R2. The latter chain of reactions is at the base of all photochemical ozone formation in the troposphere, including that taking place during photochemical smog episodes, originally discovered in southern California, as discussed by Johnston (28). Such reactions can, however, also take place in background air with ubiquitous CO and  $CH_4$ , serving as fuels: in the case of CO oxidation

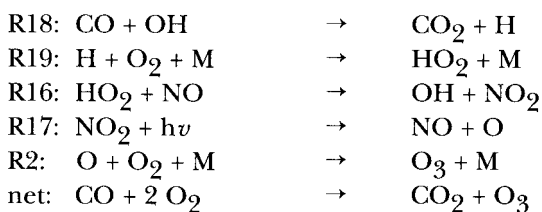

This reaction chain requires the presence of sufficient concentrations of NO. At low NO volume mixing ratios, below about 10 pmole/mole ( $p = \text{pico} = 10^{-12}$ ), oxidation of CO may lead to ozone destruction since the  $HO_2$  radical then reacts mostly with  $O_3$ :

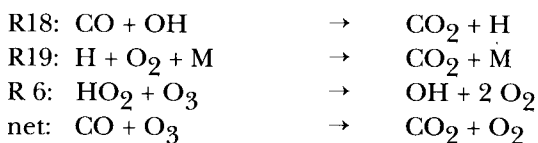

In a similar way, the oxidation of  $\text{CH}_4$  in the presence of sufficient  $\text{NO}_x$  will lead to tropospheric ozone production.

Besides reacting with  $\text{NO}$  or  $\text{O}_3$ ,  $\text{HO}_2$  can also react with itself



to produce  $\text{H}_2\text{O}_2$  which serves as a strong oxidizer of S (IV) compounds in cloud and rain water.

My talk at the International Ozone Symposium was not well received by some members of the scientific establishment of that time. However, in the following years, the idea gradually received increased support. In particular, Bill Chameides and Jim Walker (43), then of Yale University, took it up and went as far as proposing that even the diurnal variation of lower tropospheric ozone could be explained largely by *in situ* photochemical processes. Although I did not agree with their hypothesis ( $\text{CH}_4$  and  $\text{CO}$  oxidation rates are just not rapid enough), it was good to note that my idea was being taken seriously. (I should immediately add that especially Bill Chameides in subsequent years added much to our knowledge of tropospheric ozone). A couple of years later, together with two of my finest students, Jack Fishman and Susan Solomon, we presented observational evidence for a strong *in situ* tropospheric ozone chemistry (44, 45). Laboratory measurements by Howard and Evenson (46) next showed that reaction R16 proceeded about 40 times faster than determined earlier, strongly promoting ozone production and increased OH concentrations with major consequences for tropospheric and stratospheric chemistry (47). A consequence of faster rate of this reaction is a reduction in the estimated ozone depletions by stratospheric aircraft as the ozone production reactions  $\text{R16} + \text{R17} + \text{R2}$  are favoured over the destruction reaction R6. Furthermore, a faster reaction R16 leads to enhanced OH concentrations and thus a faster conversion of reactive  $\text{NO}_x$  to far less reactive  $\text{HNO}_3$ . Table 2 summarizes a recent ozone budget calculated with a

**Table 2:** Tropospheric ozone budgets, globally and for the northern (NH) and southern (SH) hemisphere in  $10^{13}$  mole/year. Only  $\text{CH}_4$  and  $\text{CO}$  oxidation cycles were considered. Calculations were made with the latest version of the global, three-dimensional MOGUNTIA model (48).

|   | Global | NH  | SH  |
|---|--------|-----|-----|
| Sources   |        |     |     |
| $\text{HO}_2 + \text{NO}$                               | 6.5    | 4.1 | 2.4 |
| $\text{CH}_3\text{O}_2 + \text{NO}$                     | 1.7    | 1.0 | 0.7 |
| Transport from stratosphere                             | 1.0    | 0.7 | 0.3 |
| Sinks   |        |     |     |
| $\text{O}(^1\text{D}) + \text{H}_2\text{O}$             | 3.8    | 2.2 | 1.6 |
| $\text{HO}_2 + \text{O}_3$ and $\text{OH} + \text{O}_3$ | 2.8    | 1.8 | 1.0 |
| Deposition on surface                                   | 2.7    | 1.8 | 0.9 |
| Net chemical source                                     | 1.6    | 1.1 | 0.5 |

three-dimensional chemistry transport model of the troposphere. The results clearly show the dominance of *in situ* tropospheric ozone production and destruction. With the same model, estimates were also made of the present and pre-industrial ozone concentration distributions. The calculations, shown in Figures 4 and 5, indicate a clear increase in tropospheric ozone

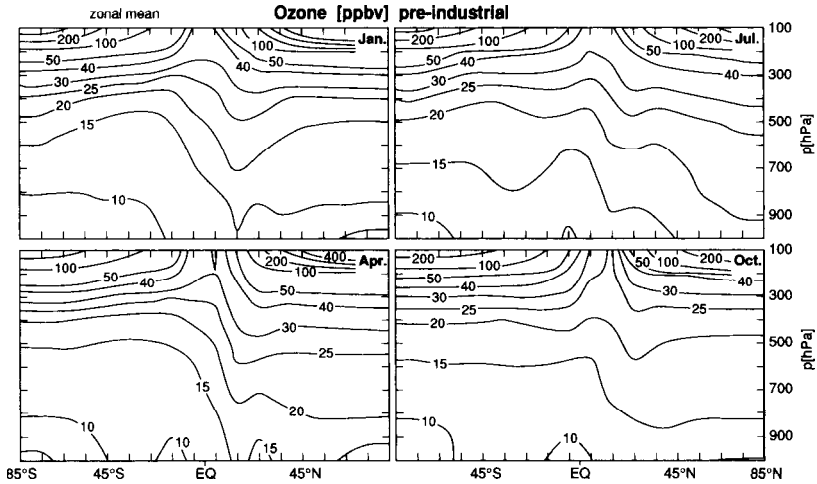

Figure 4: Calculated zonal average ozone volume mixing ratios in units of nanomole/mole (or ppbv) for the pre-industrial era (nano =  $10^{-9}$ ) for different months.

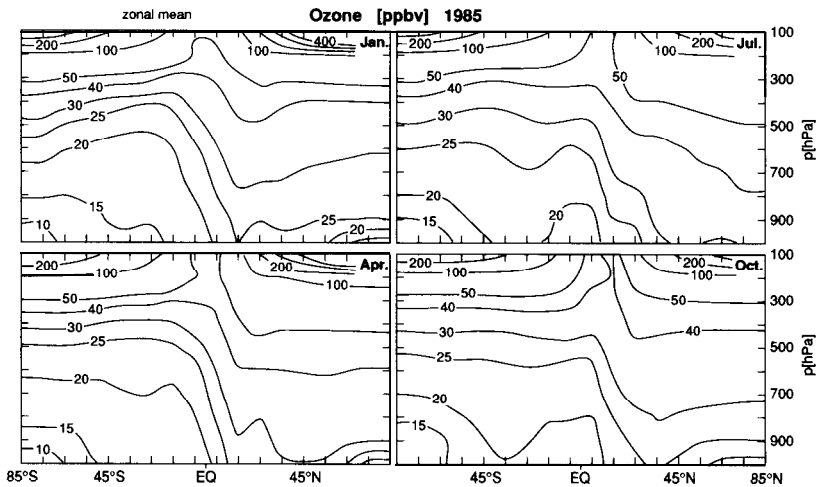

Figure 5: Same as figure 4, but for mid-1980's.

concentrations over the past centuries (48). In Figure 6 we also show the meridional cross sections of zonal average ozone, as compiled by Jack Fishman (unpublished data).

With the same model we have also calculated the OH concentration distributions for pre-industrial and present conditions. Since pre-industrial times,  $\text{CH}_4$  volume mixing ratios in the atmosphere has increased (49) from



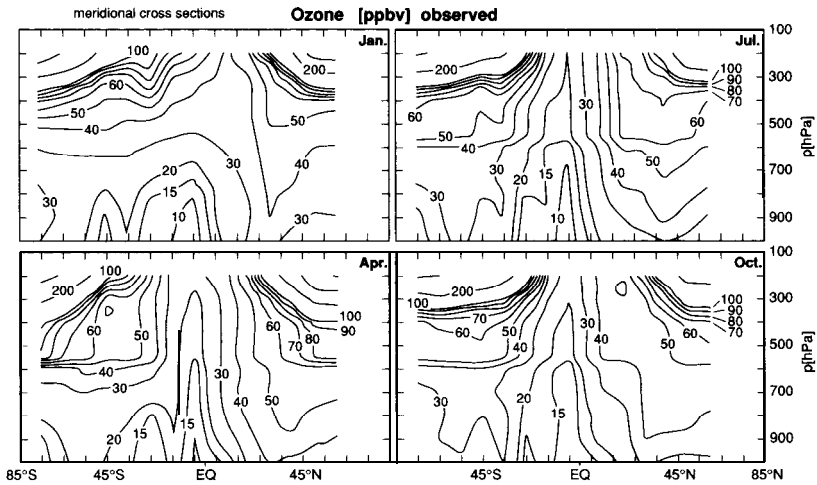

Figure 6: Compilation of observed ozone distributions prior to 1989, compiled by Jack Fishman of NASA Langley Research Center. It should be mentioned that the data base is very limited and has not much improved for the tropics and subtropics.

about 0.7 to 1.7 ppmv ( $1 \text{ ppmv} = 10^{-6} \text{ volume/volume}$ ). Because reaction with  $\text{CH}_4$  is one of the main sinks for OH, an increase in  $\text{CH}_4$  should have led to a decrease in OH concentrations. On the other hand, increased ozone concentrations, leading to enhanced OH production by reactions R7 + R8, and the effect of the reactions,



and



both stimulated by strongly enhanced anthropogenic NO production, should have worked in the opposite direction. Figures 7 and 8 show calculated zonally and diurnally averaged, meridional distributions of the OH con-

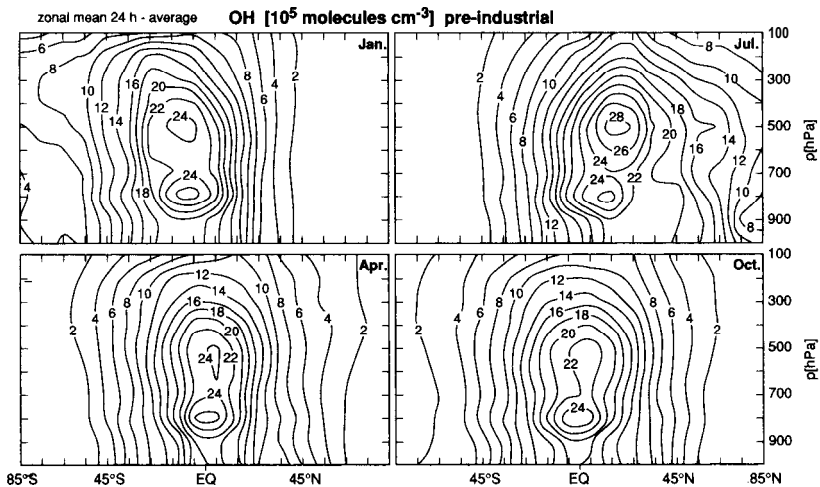

Figure 7: Calculated zonal and 24-hour average OH concentrations in units of  $10^5 \text{ molecules/cm}^3$  for the pre-industrial period for January, April, July and October.

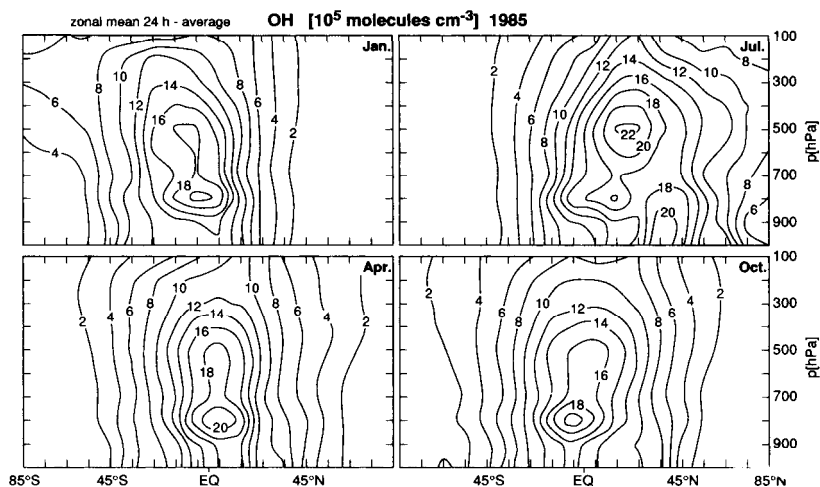

Figure 8: Same as figure 7 for 1985.

- centrations, both for the pre-industrial and industrial periods. They indicate:
- strong maxima of OH concentrations in the tropics, largely due to high intensities of ultraviolet radiation as a consequence of a minimum vertical ozone column. Consequently the atmospheric oxidation efficiency is strongly determined by tropical processes. For instance, most  $\text{CH}_4$  and CO is removed from the atmosphere by reaction with OH in the tropics.
  - the possibility of a significant decline in OH concentrations from pre-industrial to industrial conditions.

The results presented in Figure 8 are of great importance, as they allow estimations of the sink of atmospheric  $\text{CH}_4$  by reaction with OH. Prior to the discovery of the fundamental role of the OH radical (37), estimates of the sources and sinks of trace gases were largely based on guess work without a sound scientific basis. As shown in Table 3, this recognition has led to very large changes in the budget estimates of  $\text{CH}_4$  and CO. "Authoritative" estimates of the  $\text{CH}_4$  budget of 1968 (no reference will be given) gave much higher values for  $\text{CH}_4$  releases from natural wetlands. With such a dominance of natural sources, it would have been impossible to explain the annual increase in atmospheric  $\text{CH}_4$  concentrations by almost 1% per year. Early estimates of CO sources, on the other hand, were much too low.

The dominance of OH concentrations and the high biological productivity in the tropics clearly points at the great importance of the tropics and subtropics in atmospheric chemistry. Despite this fact, research on low latitude chemistry is much neglected, such that we do not even have satisfactory statistics on the ozone distribution in this part of the world. Tropical chemistry is a topic which has played and will continue to play a large role in my research. Contrary to what was commonly believed prior to the early 1980's, the chemical composition of the tropical and subtropical atmosphere is substan-

Table 3: Estimated budgets of important atmospheric trace gases made in 1968 and at present.

DMS denotes dimethylsulfide

|  | 1968                       | 1995                    |
|--|----------------------------|-------------------------|
| <b>CH<sub>4</sub> BUDGET (Tg/year)</b>   |                            |                         |
| Natural wetlands                         | 1180                       | 275                     |
| Anthropogenic                            | <u>270</u>                 | <u>265</u>              |
|  | 1450                       | 540                     |
| <b>CO BUDGET (Tg/year)</b>               |                            |                         |
| Natural                                  | 75                         | 860                     |
| Anthropogenic                            | <u>274</u>                 | <u>1640</u>             |
|  | 350                        | 2500                    |
| <b>S BUDGET (Tg S/year)</b>              |                            |                         |
| Pollutants                               | 76                         | 78                      |
| Oceanic emissions                        | 30 (H <sub>2</sub> S)      | 25 (DMS)                |
| Land emissions                           | <u>70 (H<sub>2</sub>S)</u> | few (various compounds) |
|  | 176                        | 105                     |
| <b>NO<sub>x</sub> BUDGET (Tg N/year)</b> |                            |                         |
| Biological                               | 150                        | 10                      |
| Pollution                                | 15                         | 24                      |
| Lightning                                | <u>-</u>                   | <u>2-10</u>             |
|  | 165                        | 36-44                   |
| <b>N<sub>2</sub>O BUDGET (Tg N/year)</b> |                            |                         |
| Biological                               | 340                        | 15                      |
| Anthropogenic                            | <u>-</u>                   | <u>3.5</u>              |
|  | 340                        | 18.5                    |

tially affected by human activities, in particular biomass burning which takes place during the dry season. The high temporal and spatial variability of ozone in the tropics is shown in figure 9. Highest ozone concentrations are

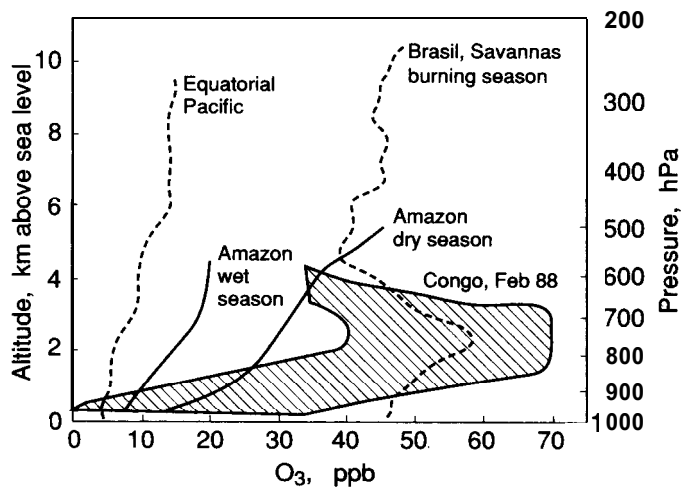

Figure 9: Variability of ozone profiles in the tropics, including contrast between dry and wet season, and continents versus marine soundings.

observed over the polluted regions of the continents during the dry season, lowest values in the clean air over the Pacific. I will return to the topic of tropical tropospheric ozone, but will first review the stormy developments in stratospheric ozone depletion by halogen compounds that started in 1974.

#### POLLUTION OF THE STRATOSPHERE BY ClO<sub>x</sub>

Towards the end of the CIAP programme some researchers had turned their interest to the potential input of reactive chlorine radicals on stratospheric ozone. In the most thorough of these studies, Stolarski and Cicerone (50) calculated significant ozone depletions if inorganic chlorine were to be present in the stratosphere at a volume mixing ratio of 10<sup>-9</sup> mole/mole of air (1 nanomole/mole). Odd oxygen destruction would take place via the catalytic reaction cycle



This reaction sequence is very similar to the catalytic NO<sub>x</sub> cycle R11 + R12 introduced before. The study by Stolarski and Cicerone, first presented at a conference in Kyoto, Japan, in the fall of 1973, mainly considered volcanic injections as a potential source of ClO<sub>x</sub> (their initial interest in chlorine chemistry was, however, concerned with the impact of the exhaust of solid rocket fuels of the space shuttle). Two other conference papers (51, 52), also dealt with ClO<sub>x</sub> chemistry. All three papers struggled, however, with the problem of a missing chlorine source in the stratosphere (research over the past 20 years has shown that the volcanic source is rather insignificant).

In the fall of 1973 and early 1974 I spent some time looking for potential anthropogenic sources of chlorine in the stratosphere. Initially my main interest was with DDT and other pesticides. Then by the beginning of 1974 I read a paper by James Lovelock and coworkers (53) who reported atmospheric measurements of CFCI<sub>3</sub> (50 picomole/mole) and CC14 (71 pmole/mole) over the Atlantic. (Such measurements had been made possible by Lovelock's invention of the electron capture detector for gas chromatographic analysis, a major advance in the environmental sciences). Lovelock's paper gave me the first estimates of the industrial production rates of CF<sub>2</sub>Cl<sub>2</sub> and CFCI<sub>3</sub>. It also stated that these compounds "are unusually stable chemically and only slightly soluble in water and might therefore persist and accumulate in the atmosphere ... The presence of these compounds constitutes no conceivable hazard". This statement had just aroused my curiosity about the fate of these compounds in the atmosphere when a preprint of a paper by M.J. Molina, and F.S. Rowland with the title "Stratospheric Sink for Chlorofluoromethanes - Chlorine Atom Catalyzed Destruction of Ozone" was sent to me by the authors. I knew immediately that this was a very important paper and decided to mention it briefly during

a presentation on stratospheric ozone to which I had been invited by the Royal Swedish Academy of Sciences in Stockholm. What I did not know was that the press was likewise invited to the lecture. To my great surprise, within a few days, an article appeared in the Swedish newspaper "Svenska Dagbladet". This article quickly attracted wide international attention and soon I was visited by representatives of the German chemical company Hoechst and also by Professor Rowland, who at that time was spending a sabbatical year at the Atomic Energy Agency in Vienna. This was the first time I had heard of Molina or Rowland, which is not surprising as they had not been active in studies on the chemistry of the atmosphere. Needless to say, I remained highly interested in the topic and by September, 1974, about 2 months after the publication of Molina's and Rowland's paper (54) I presented a model analysis of the potential ozone depletion resulting from continued use of the chlorofluorocarbons (CFC's) (55) which indicated the possibility of up to about 40% ozone depletion near 40 km altitude as a result of continued use of these compounds at 1974 rates. Almost simultaneously, Cicerone et al. (56) published a paper in which they predicted that by 1985-1990, continued use of CFCs at early 1970's levels could lead to  $\text{ClO}_x$  catalyzed ozone destruction of a similar magnitude as the natural sinks of ozone. Following Molina's and Rowland's proposal, research on stratospheric chemistry further intensified, now with the emphasis on chlorine compounds.

By the summer of 1974, together with my family, I moved to Boulder, Colorado, where I assumed two halftime positions, one as a consultant at the Aeronomy Laboratory of the National Oceanic and Atmospheric Administration (NOAA), the other at the Upper Atmosphere Project of the National Center for Atmospheric Research (NCAR). The NOAA group, which under the able direction of Dr. Eldon Ferguson had become the world leading group in the area of laboratory studies of ion-molecule reactions, had just decided to direct their considerable experimental skills to studies of stratospheric chemistry. My task was to guide them in that direction. I still feel proud to have been part of a most remarkable transformation. Together with Eldon Ferguson, scientists like Dan Albritton, Art Schmeltekopf, Fred Fehsenfeld, Paul Goldan, Carl Howard, George Reid, John Noxon, and Dieter Kley rapidly made major contributions to stratospheric research, including such activities as air sampling with balloon borne evacuated cans, so-called "salad bowls" for later gas-chromatographic analysis, optical measurements of the vertical abundances and distributions of  $\text{NO}_2$  and  $\text{NO}_3$  (later expanded by Susan Solomon to  $\text{BrO}$  and  $\text{OCIO}$ ), the design and operation of an instrument to measure extremely low water vapour mixing ratios, and laboratory simulations of important, but previously poorly known rate coefficients of important reactions. In later years the NOAA group also devoted itself to studies of tropospheric chemistry, reaching a prominent position in this research area as well. At NCAR the emphasis was more on infrared spectrographic measurements by John Gille and Bill Mankin, work

which also developed into satellite-borne experiments. Another prominent activity was the analysis of the vertical distributions of less reactive gases, such as  $\text{CH}_4$ ,  $\text{H}_2\text{O}$ ,  $\text{N}_2\text{O}$ , and the CFC's, employing the cryogenic sampling technique which had been pioneered by Ed Martell and Dieter Ehhalt.

In 1977, I took up the directorship of the Air Quality Division of NCAR, my first partially administrative position. I continued, however, my scientific work, something which many thought would be impossible. Fortunately, in Nelder Medrud I had a highly competent administrative officer. In my position as director I promoted work on both stratospheric and tropospheric chemistry. My own research was mostly devoted to the development of photochemical models, conducted mostly with my students Jack Fishman, Susan Solomon and Bob Chatfield. Together with Pat Zimmerman we started studies on atmosphere-biosphere interactions, especially the release of hydrocarbons from vegetation and pollutant emissions due to biomass burning in the tropics. I also tried to strengthen interactions between atmospheric chemists and meteorologists to improve the interpretation of the chemical measurements obtained during various field campaigns. To get this interdisciplinary research going was a challenge, particularly in those days.

During this period, as part of various US and international activities, much of my research remained centered on the issue of anthropogenic, chlorine-catalyzed ozone destruction. However, because I am sure that this topic will be covered extensively by my two fellow recipients of this year's Nobel Prize, I would like to make a jump to the year 1985, when Joe Farman and his colleagues (57) of the British Antarctic Survey published their remarkable set of October total ozone column measurements from the Halley Bay station, showing a rapid depletion on the average by more than 3% per year, starting from the latter half of the 1970's. Although their explanation ( $\text{ClO}_x/\text{NO}_x$  interactions) was wrong, Farman et al. (57) correctly suspected a connection with the continued increase in stratospheric chlorine (nowadays more than 5 times higher than natural levels). Their display of the downward trend of ozone, matching the upward trend of the chlorofluorocarbons (with the appropriate scaling) was indeed highly suggestive.

The discovery of the ozone hole came during a period in which I was heavily involved in various international studies on the potential environmental impacts of a major nuclear war between the NATO and Warsaw Pact nations, an issue to which I will briefly return in one of the following chapters. Because so many researchers became quickly involved in the "ozone hole" research, initially I stayed out of it. Then, in early 1986 I attended a scientific workshop in Boulder, Colorado, which brought me up-to-date with the various theories which had been proposed to explain the ozone hole phenomenon. Although it turned out that some of the hypotheses had elements of the truth, in particular the idea put forward by Solomon et al. (58) of chlorine activation on the surface of stratospheric ice particles, via the reaction,

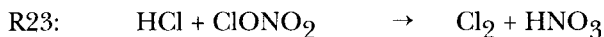

followed by rapid photolysis of Cl<sub>2</sub> and production of highly reactive Cl atoms

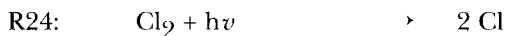

I felt dissatisfied with the treatment of the heterogeneous chemistry. On my flight back to Germany (I hardly sleep on trans-Atlantic flights), I had good time to think it over and suddenly realized that if HNO<sub>3</sub> and NO<sub>x</sub> were removed from the gas phase into the particulate phase, then an important defense against the attack of ClO<sub>x</sub> on O<sub>3</sub> would be removed. The thought goes as follows. Under normal stratospheric conditions, there are strong interactions between the NO<sub>x</sub> and ClO<sub>x</sub> radicals which lead to protection of ozone from otherwise much more severe destruction. Important examples of these are the reactions,



and the pair of reactions,



producing HCl and ClONO<sub>2</sub>, which do not react with O or O<sub>3</sub>. Due to these reactions, under normal stratospheric conditions most of the inorganic chlorine is present as HCl and ClONO<sub>2</sub>. Like two mafia families, the ClO<sub>x</sub> and NO<sub>x</sub> thus fight each other, to the advantage of ozone. As shown in Figure 10, there are plenty of complex interactions between the OX, HX,

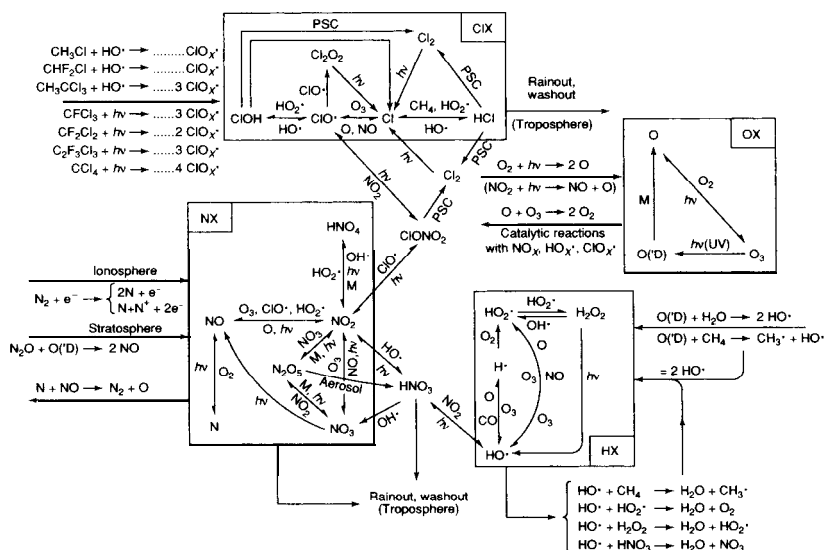
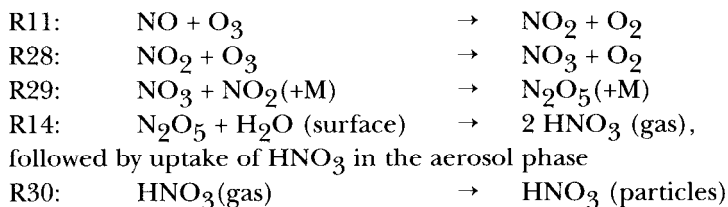
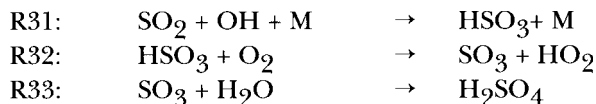

Figure 10: Schematic presentation of the chemical interactions in the stratosphere. At the start of my scientific career only the OX and some of the HX reactions had been taken into account. Note that OX stands for the odd oxygen compounds, HX for H, OH, HO<sub>2</sub> and H<sub>2</sub>O<sub>2</sub>; NX for N, NO, NO<sub>2</sub>, NO<sub>3</sub>, N<sub>2</sub>O<sub>5</sub>, HNO<sub>3</sub> and HNO<sub>4</sub>; and CIX for all inorganic chlorine compounds, Cl, ClO, Cl<sub>2</sub>O<sub>2</sub>, ClONO<sub>2</sub>, HCl, ClOCl and Cl<sub>2</sub>. Not included are the bromine compounds which likewise play a significant role in stratospheric ozone depletion.

NX and ClX families. (We should even have included BrX). Now, if the NX compounds were removed from the gas phase, then reactions R25-R27 would not occur and most inorganic chlorine would be available in the activated, ozone destroying forms. A possible scenario would involve conversion of  $\text{NO}_x + \text{HNO}_3$ , via the nighttime reactions



As noted before, reaction R14 does not occur in the gas phase, but it readily occurs on wetted particulate surfaces. These are always present in the lower stratosphere in the form of sulfate particles, a fact which was first discovered by Christian Junge, a pioneer in atmospheric chemistry and my predecessor as director at the Max-Planck-Institute of Chemistry in Mainz (59). The sulfate particles are formed by nucleation of gas phase  $\text{H}_2\text{SO}_4$  which is formed from  $\text{SO}_2$ , following attack by OH (60, 61)



The sources of stratospheric  $\text{SO}_2$  are either direct injections by volcanic explosions (59) or oxidation of OCS, produced at the earth's surface (62) via

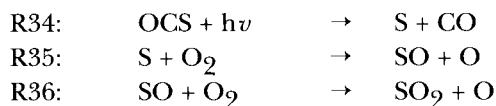

The possibility of  $\text{HNO}_3$  formation via heterogeneous reactions on sulfate particles was already considered in a 1975 paper which I co-authored with Richard Cadle and Dieter Ehhalt (63). Based on laboratory experiments, this reaction was, however, for a long while thought to be unimportant, until it was discovered that the original laboratory measurements were grossly incorrect and that reaction R14 readily occurs on  $\text{H}_2\text{O}$  containing surfaces (64-66). (Earlier tropospheric measurements had already indicated this (67)). The introduction of reaction R14 leads to a significant conversion of reactive  $\text{NO}_x$  to much less reactive  $\text{HNO}_3$  thus diminishing the role of  $\text{NO}_x$  in ozone chemistry, especially in the lower stratosphere. By including reaction R14, better agreement is obtained between theory and observations



(68). The experience with reaction R14 and earlier discussed reactions R6, R14 and R15, emphasizes the importance of high quality measurements.

As soon as I had returned to Mainz, I contacted Dr. Frank Arnold of the Max-Planck-Institute for Nuclear Physics in Heidelberg to explain to him my idea about NO<sub>x</sub> removal from the gas phase. After about a week he had shown that under stratospheric conditions, solid nitric acid trihydrate (NAT) particles could be formed at temperatures below about 200K, that is a temperature about 10 K higher than that needed for water ice particle formation. The paper about our findings was published in *Nature* at the end of 1986 (69). Independently, the idea had also been developed by Brian Toon, Rich Turco and coworkers (70). Subsequent laboratory investigations, notably by David Hanson and Konrad Mauersberger (71) then of the University of Minnesota, provided accurate information on the thermodynamic properties of NAT. It was next also shown that the NAT particles could provide excellent surfaces to catalyze the production of ClO<sub>x</sub> by reactions R23 and R24 (72, 73). Finally, Molina and Molina (74) proposed a powerful catalytic reaction cycle, involving ClO-dimer formation,

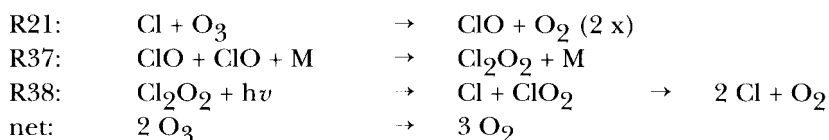

completing the chain of events causing rapid ozone depletion under cold, sunlit stratospheric conditions. Note that reaction R37 implies an ozone depletion response which is proportional to the square of the ClO concentrations. Furthermore, as chlorine activation by reaction R23 is also non-linearly dependent on the stratospheric chlorine content, a powerful non-linear, positive feedback system is created, which is responsible for the accelerating loss of ozone under "ozone hole" conditions. The "ozone hole" is a drastic example of a man-made chemical instability, which developed at a location most remote from the industrial releases of the chemicals responsible for the effect.

The general validity of the chain of events leading to chlorine activation has been confirmed by both ground based (75,76) and airborne in-situ (77) radical observations. Especially the latter, performed by James Anderson and his students of Harvard University, have been very illuminating, showing large enhancements in ClO concentrations in the cold, polar region of the lower stratosphere, coincident with a rapid decline in ozone concentrations. Together with other observations this confirms the correctness of the ozone depletion theory as outlined above. In the meanwhile the seriousness of this global problem has been recognized by all nations of the world and international agreements have been signed to halt the production of CFC's and halons from this year on. Although the cause-effect relationship is very clear, for the layperson as well, it is depressing to see that it is, nevertheless, not accepted by a small group of very vocal critics without any record of achieve-

ments in this area of research. Some of these have recently even succeeded in becoming members of the U.S. Congress.

#### AND THINGS COULD HAVE BEEN MUCH WORSE

Gradually, over a period of a century or so, stratospheric ozone should recover. However, it was a close call. Had Joe Farman and his colleagues from the British Antarctic Survey not persevered in making their measurements in the harsh Antarctic environment for all those years since the International Geophysical Year 1958/1959, the discovery of the ozone hole may have been substantially delayed and there may have been far less urgency to reach international agreement on the phasing out of CFC production. There might thus have been a substantial risk that an ozone hole could also have developed in the higher latitudes of the northern hemisphere.

Furthermore, while the establishment of an instability in the  $O_3$ -ClO<sub>x</sub> system requires chlorine activation by heterogeneous reactions on solid or supercooled liquid particles, this is not required for inorganic bromine, which is normally largely present in its activated forms due to gas phase photochemical reactions. This makes bromine on an atom to atom basis almost a hundred times more dangerous for ozone than chlorine (78, 52). This brings up the nightmarish thought that if the chemical industry had developed organobromine compounds instead of the CFCs - or alternatively, if chlorine chemistry would have run more like that of bromine - then without any preparedness, we would have been faced with a catastrophic ozone hole everywhere and at all seasons during the 1970s, probably before the atmospheric chemists had developed the necessary knowledge to identify the problem and the appropriate techniques for the necessary critical measurements. Noting that nobody had given any thought to the atmospheric consequences of the release of Cl or Br before 1974, I can only conclude that mankind has been extremely lucky, that Cl activation can only occur under very special circumstances. This shows that we should always be on our guard for the potential consequences of the release of new products into the environment. Continued surveillance of the composition of the stratosphere, therefore, remains a matter of high priority for many years ahead.

In the meanwhile, we know that freezing of  $H_2SO_4$ - $HNO_3$ - $H_2O$  mixtures to give NAT particle formation does not always occur and that supercooled liquid droplets can exist in the stratosphere substantially below NAT nucleation temperatures, down to the ice freezing temperatures (79). This can have great significance for chlorine activation (80, 81). This issue, and its implications for heterogeneous processes, have been under intensive investigation at a number of laboratories, especially in the U.S., notably by the groups headed by A.R. Ravishankara at the Aeronomy Laboratory of NOAA, Margaret Tolbert at the University of Colorado, Mario Molina at MIT, Doug Worsnop and Chuck Kolb at Aerodyne, Boston, and Dave Golden at Stanford Research Institute in Palo Alto. I am very happy that a team of young collea-

gues at the Max-Planck-Institute for Chemistry under the leadership of Dr. Thomas Peter is likewise very successfully involved in experimental and theoretical studies of the physical and chemical properties of stratospheric particles at low temperatures. A highly exciting new finding from this work was that freezing of supercooled ternary  $\text{H}_2\text{SO}_4/\text{HNO}_3/\text{H}_2\text{O}$  mixtures may actually start in the small aerosol size ranges when air parcels go through orographically induced cooling events. Under these conditions the smaller particles, originally mostly consisting of a mixture of  $\text{H}_2\text{SO}_4/\text{H}_2\text{O}$ , will most rapidly be diluted with  $\text{HNO}_3$  and  $\text{H}_2\text{O}$  and attain a chemical composition resembling that of a NAT aerosol, which, according to laboratory investigations, can readily freeze (82, 83).

### TROPICAL BIOMASS BURNING

By the end of the 1970's considerable attention was given to the possibility of a large net source of atmospheric  $\text{CO}_2$  due to tropical deforestation (84). Biomass burning is, however, not only a source of  $\text{CO}_2$ , but also of a great number of photochemically and radiatively active trace gases, such as  $\text{NO}_x$ ,  $\text{CO}$ ,  $\text{CH}_4$ , reactive hydrocarbons,  $\text{H}_2$ ,  $\text{N}_2\text{O}$ ,  $\text{OCS}$ ,  $\text{CH}_3\text{Cl}$ , etc. Furthermore, tropical biomass burning is not restricted to forest conversion, but is also a common activity related to agriculture, involving the burning of savanna grasses, wood and agricultural wastes. In the summer of 1978, on our way back to Boulder from measurements of the emissions of  $\text{OCS}$  and  $\text{N}_2\text{O}$  from feedlots in Northeastern Colorado, we saw a big forest fire high up in the Rocky Mountain National Forest, which provided us with the opportunity to collect air samples from a major forest fire plume. After chemical analysis in the NCAR Laboratories by Leroy Heidt, Walt Pollock and Rich Lueb the emission ratios of the above gases relative to  $\text{CO}_2$  could be established. Multiplying these ratios with estimates of the global extent of  $\text{CO}_2$  production by biomass burning, estimated to be of the order of  $2\text{-}4 \times 10^{15}$  g C/year (85), we next derived the first estimates of the global emissions of  $\text{H}_2$ ,  $\text{CH}_4$ ,  $\text{CO}$ ,  $\text{N}_2\text{O}$ ,  $\text{NO}_x$ ,  $\text{OCS}$  and  $\text{CH}_3\text{Cl}$ , and could show that the emissions of these gases could constitute a significant fraction of their total global emissions. These first measurements stimulated considerable international research efforts. Except for  $\text{N}_2\text{O}$  (for which our first measurements have since proved incorrect) our original findings were largely confirmed, although large uncertainties in the quantification of the various human activities contributing to biomass burning and individual trace gas releases remain (86). Because biomass burning releases substantial quantities of reactive trace gases, such as hydrocarbons,  $\text{CO}$ , and  $\text{NO}_x$ , in photochemically very active environments, large quantities of ozone were expected to be formed in the tropics and subtropics during the dry season. Several measurement campaigns in South America and Africa, starting in 1979 and 1980 with NCAR's Quemadas expedition in Brazil, have confirmed this expectation (87-92). The effects of biomass burning are especially noticeable in the industrially

lightly polluted southern hemisphere, as is clearly shown from satellite observations of the tropospheric column amounts of CO and O<sub>3</sub> in figures 11 and 12 (93, 94).

### SEASONAL DEPICTIONS OF TROPOSPHERIC OZONE DISTRIBUTION

Panels below depict global climatologies of tropospheric ozone (smog) developed at NASA Langley. Note high summertime values in the Northern Hemisphere and enhancements over South Atlantic Ocean due to widespread biomass burning in Africa. September - November

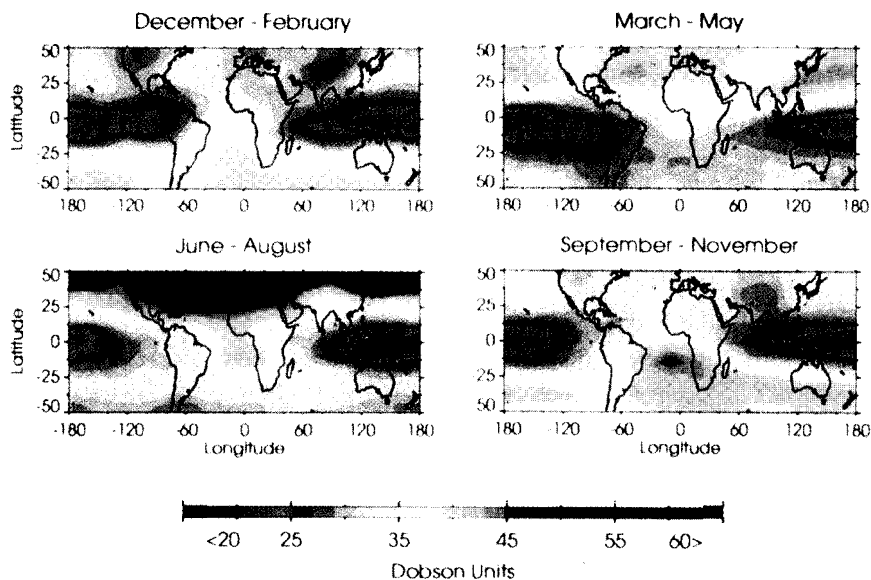

Figure 11: Observed distributions of vertical column ozone in the troposphere for 4 periods from Fishman et al. (91, 93). 1 Dobson unit represents a vertical column of  $2.62 \times 10^{16}$  molecules  $\text{cm}^{-2}$ .

### "NUCLEAR WINTER"

My research interests both in the effects of NO<sub>x</sub> on stratospheric ozone and in biomass burning explain my involvement in the "nuclear winter" studies. When in 1981 I was asked by the editor of *Ambio* to contribute to a special issue on the environmental consequences of a major nuclear war, an issue co-edited by Dr. Joseph Rotblat, this year's Nobel Peace Prize awardee, the initial thought was that I would make an update on predictions of the destruction of ozone by the NO<sub>x</sub> that would be produced and carried up by the fireballs into the stratosphere (95, 96). Prof. John Birks of the University of Colorado, Boulder, one of the co-authors of the Johnston study on this topic (96), who spent a sabbatical in my research division in Mainz, joined me in this study. Although the ozone depletion effects were significant, it was also clear to us that these effects could not compete with the direct impacts of the nuclear explosions. However, we then came to think about the potential climatic effects of the large amounts of sooty smoke from fires in the forests and in urban and industrial centers and oil storage facilities, which would reach the middle and higher troposphere. Our conclusion was that the

## Measurement of Air Pollution from Satellites

### Carbon Monoxide Mixing Ratios in Middle Troposphere during April and October 1994

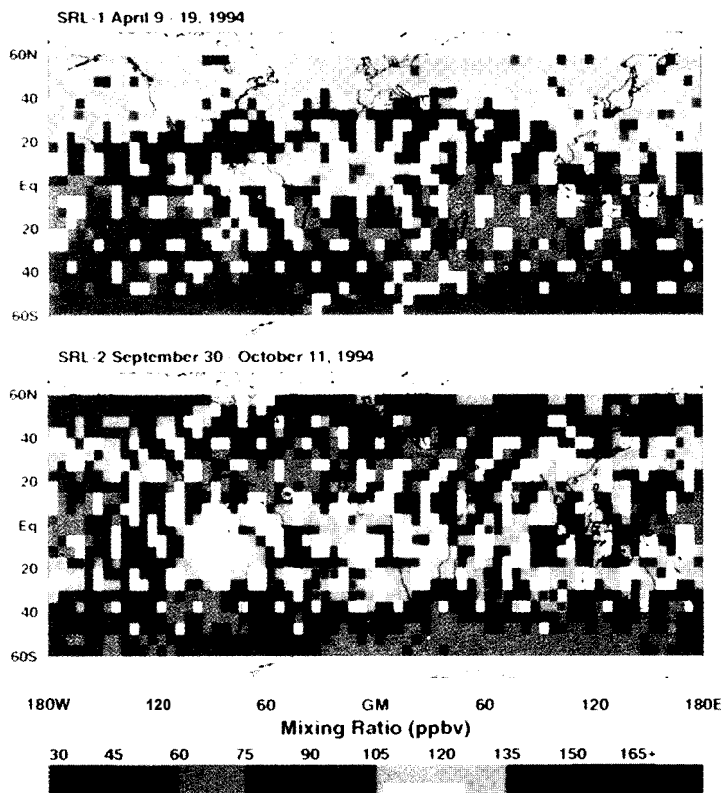

Figure 12: Observed distributions of vertical column CO in the troposphere for 4 periods, measured on the space shuttle during April and October, 1994. Courtesy of Drs. Vicki Connors, Hank Reichle and the MAPS team. Reference should be made to Connors et al. (94). (1 ppbv is the same as 1 nmole/mole).

absorption of sunlight by the black smoke could lead to darkness and strong cooling at the earth's surface, and a heating of the atmosphere at higher elevations, thus creating atypical meteorological and climatic conditions which would jeopardize agricultural production for a large part of the human population (97). This idea was picked up by others, especially the so-called TTAPS (Turco, Toon, Ackerman, Pollack, Sagan) group (98) who even predicted that subfreezing temperatures could be possible over much of the earth. This was supported by detailed climate modeling (99). A major international study of the issue which was conducted by a group of scientists working under the auspices of SCOPE (Scientific Committee on Problems of the Environment) of ICSU (International Council of Scientific Unions) also supported the initial hypothesis, concluding that far more people could die by the climatic and environmental consequences of a nuclear war than directly by the explosions (100, 101).

Although I do not count the "nuclear winter" idea among my greatest scientific achievements (in fact, the hypothesis can not be tested without performing the "experiment", which it wants to prevent), I am convinced that, from a political point of view, it is by far the most important, because it magnifies and highlights the dangers of a nuclear war and convinces me that in the long run mankind can only escape such horrific consequences if nuclear weapons are totally abolished by international agreement. I thus wholeheartedly agree in this respect with Joseph Rotblat and the Pugwash organization, this year's recipients of the Nobel Prize for Peace.

#### CURRENT RESEARCH INTERESTS

Realizing the great importance of heterogeneous reactions in stratospheric chemistry, together with my Dutch students Jos Lelieveld (now professor at the University of Utrecht) and Frank Dentener, I have been involved in studies on the effects of reactions taking place in cloud droplets and tropospheric aerosol particles. In general, such reactions result in removal of NO<sub>x</sub> and lower concentrations of O<sub>3</sub> and OH (102, 103). Furthermore, even at high enough NO<sub>x</sub> concentrations to allow ozone formation by reactions R16 + R17 + R2, such reactions would be much limited within clouds due to the fact that the NO<sub>x</sub> molecules, which are only slightly water soluble, stay in the gas phase, while the HO<sub>2</sub> radicals readily dissolve in the cloud droplets, where they can destroy ozone via the reactions,

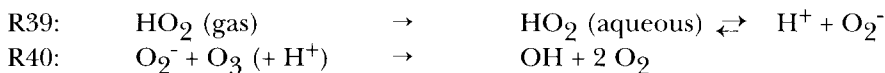

The role of rapid transport of reactive compounds from the planetary boundary layer into the upper troposphere is another topic with which I have been involved with some of my students over the past decade. This may have important effects on the chemistry of the upper troposphere (104, 105). My great interest in the role of clouds in atmospheric chemistry has brought me in close contact with a major research group at the University of California, San Diego, headed by my good friend Prof. V. Ramanathan.

A new project in which I am currently much interested is the possibility of Cl and especially Br activation in the marine boundary layer. It is already known that Br activation can explain the near-zero O<sub>3</sub> concentrations which are often found in the high latitude marine boundary layer during spring-time (106). In our most recent papers we discuss the possibility that Br activation may also occur in other marine regions and seasons (107, 108).

The ideas outlined above will be tested by field programs and, if confirmed, introduced in advanced photochemical-transport models. The field programs will be mostly carried out by members of my research division at the Max-Planck-Institute for Chemistry, often in collaboration with other experimental groups. The modeling work is conducted within a consortium

of researchers from Sweden, The Netherlands, France, Italy and Germany. This effort is funded by the European Union and coordinated by Professors Lennart Bengtsson, Hamburg, Henning Rodhe, Stockholm and Jos Lelieveld, Utrecht.

## A LOOK AHEAD

Despite the fundamental progress that has been made over the past decades, much research will be needed to fill major gaps in our knowledge of atmospheric chemistry. In closing I will try to indicate some of those research areas which I consider to be of greatest interest (109).

*Tropospheric Ozone Observations:* Despite the great importance of tropospheric ozone in atmospheric chemistry, there are still major uncertainties concerning its budget and global concentration distribution. Everywhere, but especially in the tropics and the subtropics, there is a severe lack of data on tropospheric ozone concentrations. Considering the enormous role of tropical ozone in the oxidation efficiency of the atmosphere, the already recognized large anthropogenic impact on ozone through biomass burning, and the expected major agricultural and industrial expansion of human activities in this part of the world, this knowledge gap is very serious. At this stage it is not possible to test photochemical transport models owing to severe scarcity of ozone observations, especially in the tropics and subtropics. Of critical importance in the effort to obtain data from the tropics and subtropics will be the *training and long term active participation of scientists from the developing countries*. Besides the ozone measurements at a number of stations and during intensive measurement campaigns, it will be important to also obtain data on reactive hydrocarbons, CO, NO<sub>x</sub>, NX and on chemical constituents in precipitation. Unfortunately, it has been frustrating to note how little response there has been from potential funding agencies to support efforts in this direction.

*Long-term observations of atmospheric properties:* Two major findings have demonstrated the extreme value of long term observations of important atmospheric chemical properties. One example was the discovery of the rapid depletion of stratospheric ozone over Antarctica during the spring months, as discussed before. Another is the recent, unexpected major, temporary break in the trends of CH<sub>4</sub> and CO. Most surprising were the changes in CO, for which Khalil and Rasmussen (110) derived a downward trend in surface concentrations by  $1.4 \pm 0.9\%$ /yr in the northern hemisphere and by as much as  $5.2 \pm 0.7\%$ /yr in the southern hemisphere between 1987 and 1992. Even larger downward trends,  $6.1 \pm 1\%$ /yr in the northern hemisphere and  $7 \pm 0.6\%$ /yr in the southern hemisphere, were reported for the period between June, 1990 and June, 1993 by Novelli et al. (111). Although these trends have again reversed (P. Novelli, private communication) into the previous upward trend of + 0.7% per year for CO and almost 1% per year for CH<sub>4</sub> (112, 113) the temporal break is remarkable. The reasons for this sur-

prising behaviour are not known. They may consist of a combination of: (i) variable annual emissions from biomass burning, (ii) higher concentrations of OH radicals, maybe due to loss of stratospheric ozone, triggered by an increase in reactive aerosol surfaces in the stratosphere following the Pinatubo volcanic eruption in June, 1991, (iii) a dynamically forced global redistribution of CO, introducing a bias due to the location of the limited number of measuring sites, (iv) reduced CO formation from the oxidation of natural hydrocarbons emitted by tropical forests due to globally altered precipitation and temperature patterns, or, most likely, a combination of these plus other, yet unknown factors. At this stage we can only conclude that the causes for the surprisingly rapid CO trend changes are not known, the main reason being incomplete global coverage of the CO measurement network. The same applies for CH<sub>4</sub>.

*Intensive measurement campaigns:* Comprehensive field programmes that have been conducted in the past with detailed observations of all factors that influence the photochemistry of the troposphere will also be much needed in the future, especially in various regions of the marine and continental tropics and subtropics, in order to find out whether we understand the major processes that determine the chemistry of ozone and related photochemically active compounds. Applications of comprehensive chemical-transport models should be an important part of these activities. Topics in which greatly improved knowledge is necessary, are especially: improved quantification of the stratospheric influx of ozone; distributions, sources and sinks of CH<sub>4</sub>, reactive hydrocarbons, CO, NO<sub>x</sub> and NX; quantification of natural NO emissions from lightning and soils.

*Cloud transport:* The role of clouds as transporters of boundary layer chemical constituents, such as CO, NO<sub>x</sub>, reactive hydrocarbons and their oxidation products to the middle and upper troposphere (and possibly into the lower stratosphere) should be better understood and quantified, so that they can be parameterized for inclusion in large scale photochemical models of the atmosphere. Similarly the production of NO by lightning and its vertical redistribution by convective storms should also be much better quantified, both for marine and continental conditions. Current uncertainties of NO production by lightning are at least a factor of four.

*Chemical interactions with hydrometeors:* The interactions of chemical constituents emanating from the boundary layer with liquid and solid hydrometeors in the clouds will be of special importance. There is for instance the question of why strong ozone formation has not been noticed around the most convective regions in the continental tropics in which large amounts of forest-derived reactive hydrocarbons, such as isoprene (C<sub>5</sub>H<sub>8</sub>), and their oxidation products are rapidly lifted to the middle and upper troposphere and mixed with lightning-produced NO to provide favourable conditions for photochemical ozone formation. Could it be that the expected ozone formation is prevented by chemical interactions of the hydrocarbon reaction products and NO, with the hydrometeors? Could significant ozone destruc-



tion take place in cloud water and/or on the surface of ice particles which may be partially covered by water (114, 115)? Such questions regarding potential loss of ozone by reactions with hydrometeors may be especially relevant in connection with observations of record low O<sub>3</sub> volume mixing ratios often of less than 10 ppbv in the upper kilometers of the troposphere in March 1993 in an extended, heavily convective region between Fiji and Christmas Island over the Pacific Ocean (116). Although such low ozone volume mixing ratios had been noted on several occasions in the tropical marine boundary layer and can be explained by the ozone-destroying reactions R6-R8 in the lower troposphere, it should be ascertained whether these reactions alone suffice to explain the extremely low ozone concentrations in such a large volume of air.

*Photolysis rates in cloudy atmosphere:* Regarding the photochemistry taking place in cloudy atmospheric conditions, recent observations of unexpectedly high absorption of solar radiation in cloudy atmospheres (117) point to the possibility that multiple scattering in broken cloud systems may lead to strongly enhanced photolysis rates and photochemical activity, leading e.g. to much higher O<sub>3</sub> destruction and OH production rates by reactions R7 and R8, or ozone production by reactions R16 + R17 + R2, than thought so far. The influence of clouds on the photochemically active UV radiation field is a potentially very important research topic which should be pursued by measurements and the development of appropriate radiative transfer models.

*Biogenic sources of hydrocarbons, CO and NO:* The continental biosphere is a large source of hydrocarbons. Quantification of these sources in terms of geophysical (e.g. temperature, humidity, light levels) and biogeochemical (soil physical and chemical properties, land use) parameters are urgently needed for inclusion in atmospheric models. The hydrocarbon oxidation mechanisms in the atmosphere should also be better understood, so that formation of ozone, carbon monoxide, partially oxidized gaseous hydrocarbons, and organic aerosol can be better quantified. The formation of organic aerosol from hydrocarbon precursors and their capability to serve as cloud condensation nuclei are related, potentially important, subjects which have not been studied in any depth so far.

*Potential role of halogen radicals in ozone destruction:* There are strong observational indications that tropospheric ozone can be destroyed by reactions in addition to those discussed so far. Surface ozone observations during polar sunrise in the Arctic have frequently shown the occurrence of unmeasurably low ozone concentrations, coinciding with high "filterable Br" (106). Further measurements (118) identified BrO as one of the active Br compounds, which, as is well known from stratospheric measurements, may rapidly attack ozone by a series of catalytic reactions, such as

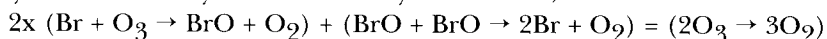

or

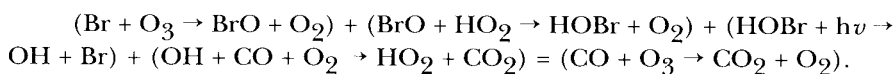

It should be explored whether halogen activation reactions may also occur under different circumstances than indicated above (106-108).

*Heterogeneous reactions on aerosol particles* The issue of interactions between gases and atmospheric aerosol is largely unexplored and very little considered in tropospheric chemistry models. Examples are interactions of dimethyl sulfide-derived sulphur compounds with seasalt in the marine boundary layer and reactions of  $\text{SO}_2$ ,  $\text{H}_2\text{O}$ ,  $\text{NO}_x$ ,  $\text{N}_2\text{O}_5$  and  $\text{HNO}_3$  on soil dust particles which remove these compounds from the gas phase. In the case of industrial  $\text{SO}_2$ , the neglect of such heterogeneous reactions may well have led to overestimations of the climatic cooling effects of anthropogenic aerosol, as any incorporation of sulphur in soil dust or sea salt will prevent the nucleation of new sunlight backscattering sulfate particles.

*Ozone/climate feedbacks in the stratosphere:* Ozone is a significant greenhouse gas with an infrared absorption band in the atmospheric window region, centered at 9.6  $\mu\text{m}$ . Although the tropospheric ozone amount is only about 10% of that of the stratosphere, the effective longwave optical depth of tropospheric ozone is larger. Of greatest importance would be any changes that might take place in the ozone concentrations in the tropopause regions as a result of human activities, such as  $\text{H}_2\text{O}$ ,  $\text{NO}$ ,  $\text{SO}_2$  and particulate emissions from expanding fleets of civil aircraft flying in the stratosphere and upper troposphere. On the one hand this may lead to increasing temperatures in the lower stratosphere. However, increased  $\text{HNO}_3$  and  $\text{H}_2\text{O}$  concentrations in the lower stratosphere may increase the likelihood of polar stratospheric particle formation and ozone destruction. Such a course of events is also promoted by cooling of the stratosphere by increasing concentrations of  $\text{CO}_2$ . (This cooling effect increases with height in the stratosphere and mesosphere. The implications of this for the future dynamics of the stratosphere, mesosphere and lower thermosphere is likewise a topic, deserving attention). Changes in chemical and radiative conditions in the lower stratosphere may, therefore, create feedbacks which we need to understand well, including understanding their potential impact on tropopause heights and temperatures, stratospheric water vapor, lower stratospheric cloud characteristics and the tropospheric hydrological cycle. Recent observations of increasing trends of water vapour concentrations in the lower stratosphere over Boulder emphasize this point (119). All these factors should be taken into account before decisions are taken on vast expansions of aircraft operations in the stratosphere.

#### ACKNOWLEDGEMENTS

Firstly, I have to thank my parents, my wife and my family for their love and support, and for creating the personal environment without which nothing will go.

I thank my secretaries Anja Wienhold and Bettina Krüger for their joyful attitude and hard work in sometimes chaotic times, especially in connection

with the "Nobelrummel". Many thanks to Geoff Harris, Mark Lawrence and Jens-Uwe Grooß for a final reading of the manuscript.

I thank my current and former students, post-docs and coworkers at the Max-Planck-Institute for Chemistry for their enthusiastic research efforts. Several of them are now professors at universities or directors of major research activities. With most of them I keep a close contact and we are friends for life.

I also thank the Max-Planck-Society and the various organizations with which I am or have been associated during my scientific career. All of them have been very important in trusting me with long-term funding and giving me excellent opportunities to do research without major interferences. I am particularly happy to be a member of the NSF Center on the role of Clouds in atmospheric Chemistry and Climate at Scripps Institution of Oceanography of the University of California, San Diego, I am learning a lot about clouds, one of the most important elements in the climate system. I thank my good friend, Prof. V. Ramanathan, and SIO for this great opportunity to rejuvenate myself during a few months of the year.

I thank my director colleagues and personnel of the Max-Planck-Institute for Chemistry, the University of Mainz, the City of Mainz, and the "Sonderforschungsbereich" for a wonderful welcome and party after my return to Mainz as a fresh Nobel Laureate following a brief vacation in Spain. I will also never forget my "homecoming" at MISU, Stockholm and the welcome (with illegal fireworks) by my Dutch students and "grandstudents" in Wageningen, The Netherlands.

Finally, I have to thank the many colleagues, all around the world, who have congratulated me on the Nobel Prize award. Many of them have themselves contributed greatly to the remarkable progress in our research field over the past quarter of a century; only a few of these I could recognize in this Nobel Lecture. As most of them have written, this is an award to the entire atmospheric chemistry and environmental field. I totally agree and thank you all.

And last, but not least, a great Thank You to the Nobel Committee of the Royal Swedish Academy of Sciences. Your decision is an enormous boost for environmental research

## REFERENCES

1. Sweden's Case Study for the United Nations Conference on the Human Environment 1972: Air Pollution Across National Boundaries. The Impact on the Environment of Sulfur in Air and Precipitation, Stockholm, 1972.
2. Chapman, S., A theory of upper atmospheric ozone, *Mem. Roy. Soc.*, 3, 103-125, 1930.
3. Benson, S.W. and A.E. Axworthy, Reconsiderations of the rate constants from the thermal decomposition of ozone, *J. Chem. Phys.*, 42, 2614, 1965.
4. Bates, D.R. and M. Nicolet, The photochemistry of atmospheric water vapour, *J. Geophys. Res.*, 55, 301, 1950.
5. McCrath, W.D. and R.G.W. Norrish, Studies of the reaction of excited oxygen atoms and molecules produced in the flash photolysis of ozone, *Proc. Roy. Soc. A* 254, 317, 1960.
6. Norrish, R.G.W. and R.P. Wayne. The photolysis of ozone by ultraviolet radiation. "The photolysis of ozone mixed with certain hydrogen-containing substances. *Proc. Roy. Soc. London, A* 288, 361, 1965.
7. Hampson, J., Chemiluminescent emission observed in the stratosphere and mesosphere, in "Les problèmes météorologiques de la stratosphère et de la mésosphère", p. 393. Presses universitaires de France, Paris, 1965.
8. Hunt, B.G., Photochemistry of ozone in a moist atmosphere, *J. Geophys. Res.*, 71, 1385, 1966.
9. Crutzen, P.J., Determination of parameters appearing in the "dry" and "wet" photochemical theories for ozone in the stratosphere, *Tellus*, 21, 368-388, 1969.
10. Murcray, D.G., T.G. Kyle, F.H. Murcray and W.J. Williams, Nitric acid and nitric oxide in the lower stratosphere, *Nature*, 218, 78, 1968.
11. Rhine, P.E., L.D. Tubbs and D. Williams, Nitric acid vapor above 19 km in the Earth's atmosphere, *Appl. Optics*, 8, 1501, 1969.
12. Crutzen, P.J., The influence of nitrogen oxides on the atmospheric ozone content, *Q.J.R. Meteorol. Soc.*, 96, 320-325, 1970.
13. Bates, D.R. and P.R. Hays, Atmospheric nitrous oxide, *Planet. Space Sci.*, 15, 189, 1967.
14. Greenberg, R.I. and J. Heicklen. Reaction of O(1D) with N<sub>2</sub>O, *Int. J. Chem. Kin.*, 2, 185, 1970.
15. Crutzen, P.J., Ozone production rates in an oxygen-hydrogen-nitrogen oxide atmosphere, *J. Geophys. Res.*, 76, 7311, 1971.
16. McElroy, M.B. and J.C. McConnell. Nitrous oxide. A natural source of stratospheric NO, *J. Atmos. Sci.*, 28, 1085, 1971.
17. Davis, D.D. et al., Recent kinetic measurements on the reactions of O(3p), H and HO<sub>2</sub>, Second Conference on CIAP, p. 126, DOT-TSC-OST-73-4, 1973.
18. Yoshino, K. et al., Improved absorption cross-sections of oxygen in the wavelength region 205-240 nm of the Herzberg Continuum, *Planet. Space Sci.*, 36, 1469, 1988.
19. Frederick, J.E. and J.E. Mentall, Solar irradiance in the stratosphere: Implications for the Herzberg Continuum Absorption of O<sub>2</sub>, *Geophys. Res. Lett.*, 9, 461, 1982.
20. Nicolet, M., The solar spectral irradiance and its action in the atmospheric photodissociation processes, *Planet. Space Sci.*, 29, 951, 1981.
21. Weiss, R.F., The temporal and spatial distribution of tropospheric nitrous oxide, *J. Geophys. Res.*, 86, 7185, 1981.
22. SCEP (Study on Critical Environmental Problems). Man's Impact on the Global Environment. Assessment and Recommendations for Action, The MIT Press. Cambridge, MA and London, England, 1970.
23. Nicolet, M., Nitrogen oxides in the chemosphere, *J. Geophys. Res.*, 70, 679, 1965.
24. Harrison, H.S., Stratospheric ozone with added water vapour: influence of high altitude aircraft, *Science*, 170, 734, 1970.
25. Johnston, H.S. and H.J. Crosby. Kinetics of the fast gas phase reaction between ozone and nitric oxide, *J. Chem. Phys.*, 22, 689, 1954,
26. Johnston, H.S. and D. Marvin, Working Papers for a Survey of Rate Data for Chemical Reactions in the Stratosphere, National Bureau of Standards, Report 10931, 1972.

27. Johnston, H., Reduction of stratospheric ozone by nitrogen oxide catalysts from supersonic transport exhaust, *J. Geophys. Res.*, 173, 517, 1971.
28. Johnston, H.S., Atmospheric Ozone, *Annu. Rev. Phys. Chem.*, 43, 1, 1992.
29. Johnston, H.S. and R.A. Graham, Photochemistry of NO<sub>x</sub> and HNO<sub>x</sub> compounds, *Can. J. Chem.*, 52, 1415, 1974.
30. CIAP (Climate Impact Assessment Program). Report of Findings: The Effects of Stratospheric Pollution by Aircraft, DOT-TX-75-50, U.S. Department of Transportation, Washington, DC, 1974.
31. COMESA. The Report of the (Committee on Meteorological Effects of Stratospheric Aircraft, U.K. Meteorological Office, Bracknell, England, 1975.
32. COVOS, Comité d'Etudes sur les Consequences des Vols Stratosphériques, Société Météorologique de France, Boulogne, France, 1976.
33. NAS (National Academy of Sciences). Environmental Impact of Stratospheric Flight, ISBN O-309-023467, Washington, DC, 1975.
34. Crutzen, P.J., I.S.A. Isaksen and G.C. Reid, Solar proton events: Stratospheric sources of nitric oxide, *Science*, 189, 457, 1975.
35. Heath, D.F., A.J. Krueger and P.J. Crutzen, Solar proton event: Influence on stratospheric ozone, *Science*, 197, 886, 1977.
36. Solomon, S. and P.J. Crutzen, Analysis of the August 1972 solar proton event, including chlorine chemistry, *J. Geophys. Res.*, 86, 1140, 1981.
37. Levy, H., 111, Normal atmosphere: Large radical and formaldehyde concentrations predicted, *Science*, 173, 141, 1971.
38. McConnell, J.C., M.B. McElroy and S.C. Wofsy, Natural sources of atmospheric CO, *Nature*, 233, 187, 1971.
39. Prinn, R.G. et al., Atmospheric trends and lifetime of trichloroethane and global average hydroxyl radical concentrations based on 1978-1994 ALE/GAGE measurements, *Science*, 269, 187, 1995.
40. Levy, H., III, Photochemistry of the lower troposphere, *Planet. Space Sci.*, 20, 919, 1972.
41. Crutzen, P.J., A discussion of the chemistry of some minor constituents in the stratosphere and troposphere, *Pure Appl. Geophys.*, 106-108, 1385, 1973.
42. Crutzen, P.J., Photochemical reactions initiated by and influencing ozone in unpolluted tropospheric air, *Tellus*, 26, 47, 1974.
43. Chameides, W.L. and J.C.G. Walker, A photochemical theory of tropospheric ozone, *J. Geophys. Res.*, 78, 87.51, 1973.
44. Fishman, J. and P.J. Crutzen, The origin of ozone in the troposphere, *Nature*, 274, 855, 1978.
45. Fishman, J., S. Solomon and P.J. Crutzen, Observational and theoretical evidence in support of a significant in-situ photochemical source of tropospheric ozone, *Tellus*, 31, 432, 1979.
46. Howard, C.J. and K.M. Evenson, Kinetics of the reaction of HO<sub>2</sub> radicals with NO, *Geophys. Res. Lett.*, 4, 437, 1977.
47. Crutzen, P.J. and C.J. Howard, The effect of the HO<sub>2</sub>+ NO reaction rate constant on one-dimensional model calculations of stratospheric ozone depletions, *Pure and Appl. Geophys.*, 116, 497, 1978.
48. Crutzen, P.J. and P.H. Zimmermann, The changing photochemistry of the troposphere, *Tellus*, 43 A/B, 136, 1991.
49. Intergovernmental Panel on Climate Change, *Climate Change: The IPCC Scientific Assessment* (J.T. Houghton et al., Eds.), Cambridge University Press, 365 pp, 1990.
50. Stolarski, R.S. and R.J. Cicerone, Stratospheric chlorine: A possible sink for ozone, *Can. J. Chem.*, 52, 1610, 1974.
51. Wofsy, S.C. and M.B. McElroy, HO<sub>x</sub>, NO<sub>x</sub> and ClO<sub>x</sub> Their- role in atmospheric photochemistry, *Can. J. Chem.*, 52, 1582, 1974.
52. Crutzen, P.J., A review of upper atmospheric photochemistry, *Can. J. Chem.*, 52, 1569, 1974.
53. Lovelock, J.E., R.J. Maggs and R.J. Wade, Halogenated hydrocarbons in and over the Atlantic, *Nature*, 241, 194, 1973.

54. Molina, M.J. and F.S. Rowland, Stratospheric sink of chlorofluoromethanes: Chlorine atom-catalyzed destruction of ozone, *Nature*, 249, 810, 1974.
55. Crutzen, P.J., Estimates of possible future ozone reductions from continued use of fluoro-chloro-methanes ( $\text{CF}_2\text{Cl}_2$ ,  $\text{CFCl}_3$ ), *Geophys. Res. Lett.*, 1, 205, 1974.
56. Cicerone, R.J., R.S. Stolarski and S. Walters, Stratospheric ozone destruction by man-made chlorofluoromethanes, *Science*, 185, 1165, 1974.
57. Farman, J.C., B.C. Gardiner and J.D. Shanklin, Large losses of total ozone in Antarctica reveal seasonal  $\text{ClO}_x/\text{NO}_x$  interaction, *Nature*, 315, 201, 1985.
58. Solomon, S., R.R. Garcia, F.S. Rowland, and D.J. Wuebbles, On the depletion of Antarctic ozone, *Nature*, 321, 755, 1986.
59. Junge, C.E., C.W. Chagnon and J.E. Manson, Stratospheric aerosols, *J. Meteorol.*, 18, 81, 1961.
60. Davis, D.D., A.R. Ravishankara and S. Fischer,  $\text{SO}_2$  oxidation via the hydroxyl radical: atmospheric fate of the  $\text{HSO}_3$  radicals, *Geophys. Res. Lett.*, 6, 113, 1979.
61. Stockwell, W.R. and J.G. Calvert, The mechanism of the  $\text{HO-SO}_2$  reaction, *Atmos. Environ.*, 17, 2231, 1983.
62. Crutzen, P.J., The possible importance of CSO for the sulfate layer of the stratosphere, *Geophys. Res. Lett.*, 3, 73, 1976.
63. Cadle, R.D., P.J. Crutzen and D.H. Ehhalt, Heterogeneous chemical reactions in the stratosphere, *J. Geophys. Res.*, 80, 3381, 1975.
64. Mozurkewich, M. and J.G. Calvert, Reaction probabilities of  $\text{N}_2\text{O}_5$  on aqueous aerosols, *J. Geophys. Res.*, 93, 15889, 1988.
65. Hanson, D.R. and A.R. Ravishankara, The reaction probabilities of  $\text{ClONO}_2$  and  $\text{N}_2\text{O}_5$  on 40 to 75 percent sulfuric acid solutions, *J. Geophys. Res.*, 96, 17307, 1991.
66. Van Doren, J.M., L.R. Watson, P. Davidovits, D.R. Worsnop, M.S. Zahniser and C.E. Kolb, Temperature dependence of the uptake coefficients of  $\text{HNO}_3$ ,  $\text{HCl}$ , and  $\text{N}_2\text{O}_5$  by water droplets, *J. Phys. Chem.*, 94, 3265, 1990.
67. Platt, U., D. Perner, A.M. Winer, G.W. Harris and J.N. Pitts, Jr., Detection of  $\text{NO}_3$  in the polluted troposphere by differential optical absorption, *Geophys. Res. Lett.*, 7, 89, 1980.
68. Pommereau, J.F. and F. Goutail, Stratospheric  $\text{O}_3$  and  $\text{NO}_2$  observations at the southern polar circle in summer and fall 1988, *Geophys. Res. Lett.*, 15, 895, 1988.
69. Crutzen, P.J. and F. Arnold, Nitric acid cloud formation in the cold Antarctic stratosphere: a major cause for the springtime "ozone hole", *Nature*, 324, 651, 1986.
70. Toon, O.B., P. Hamill, R.P. Turco and J. Pinto, Condensation of  $\text{HNO}_3$  and  $\text{HCl}$  in the winter polar stratosphere, *Geophys. Res. Lett.*, 13, 1284, 1986.
71. Hanson, D.R. and K. Mauersberger, Vapor pressures of  $\text{HNO}_3/\text{H}_2\text{O}$  solutions at low temperatures, *J. Phys. Chem.*, 92, 6167, 1988.
72. Molina, M.J., T.L. Tso, L.T. Molina and F.C.-Y. Wang, Antarctic stratospheric chemistry of chlorine nitrate, hydrogen chloride and ice, *Science*, 238, 1253, 1987.
73. Tolbert, M.A., M.J. Rossi, R. Malhotra, and D.M. Golden, Reaction of chlorine nitrate with hydrogen chloride and water at Antarctic stratospheric temperatures, *Science*, 238, 1258, 1987.
74. Molina, L.T. and M.J. Molina, Production of  $\text{ClO}_2$  from the self-reaction of the  $\text{ClO}$  radical, *J. Phys. Chem.*, 91, 433, 1987.
75. de Zafra, R.L., M. Jaramillo, A. Parrish, P.M. Solomon, B. Connor, and J. Barrett, High concentration of chlorine monoxide at low altitudes in the Antarctic spring stratosphere, I. Diurnal variation, *Nature*, 328, 408, 1987.
76. Solomon, S., G.H. Mount, R.W. Sanders, and A.L. Schmeltekopf, Visible spectroscopy at McMurdo Station, Antarctica: Observations of  $\text{OCIO}$ , *J. Geophys. Res.*, 92, 8329, 1987.
77. Anderson, J.G., W.H. Brune, and M.H. Proffitt, Ozone destruction by chlorine radicals within the Antarctic vortex: The spatial and temporal evolution of  $\text{ClO-O}_3$  anticorrelation based on in situ ER-2 data, *J. Geophys. Res.*, 94, 11465, 1989.
78. Wofsy, S.C., M.B. McElroy and Y.L. Yung, The chemistry of atmospheric bromine, *Geophys. Res. Lett.*, 2, 215, 1975.
79. Dye, J.E., D. Baumgardner, B.W. Gandrud, S.R. Kawa, K.K. Kelly, M. Loewenstein,

- G.V. Ferry, K.R. Chan and B.L. Gary, Particle size distribution in Arctic polar stratospheric clouds, growth and freezing of sulfuric acid droplets, and implications for cloud formation, *J. Geophys. Res.*, 97, 8015, 1992.
80. Cox, R.A., A.R. MacKenzie, R. Müller, Th. Peter and P.J. Crutzen, Activation of stratospheric chlorine by reactions in liquid sulphuric acid, *Geophys. Res. Lett.*, 21, 1439, 1994.
  81. Hanson, D.R., A.R. Ravishankara and S. Solomon, Heterogeneous reactions in sulfuric acid aerosol: A framework for model calculations, *J. Geophys. Res.*, 99, 3615, 1994.
  82. Meilinger, S.K., T. Koop, B.P. Luo, T. Huthwelker, K.S. Carslaw, P.J. Crutzen and T. Peter, Size-dependent stratospheric droplet composition in lee wave temperature fluctuations and their potential role in PSC freezing, *Geophys. Res. Lett.*, 22, 3031, 1995.
  83. Koop, T., B.P. Luo, U.M. Biermann, P.J. Crutzen and T. Peter, Freezing of HNO<sub>2</sub>/H<sub>2</sub>SO<sub>4</sub>/H<sub>2</sub>O solutions at stratospheric temperatures: Nucleation statistics and Experiments, *J. Phys. Chem.* (to be submitted).
  84. Woodwell, G.M., R.H. Whittaker, W.A. Reiners, G.E. Likens, C.C. Delwiche and D.B. Botkin, The biota and the world carbon budget, *Science*, 199, 141, 1978.
  85. Seiler, W. and P.J. Crutzen, Estimates of gross and net fluxes of carbon between the biosphere and the atmosphere from biomass burning, *Climatic Change*, 2, 207, 1980.
  86. Crutzen, P.J. and M.O. Andreae, Biomass burning in the Tropics: Impact on atmospheric chemistry and biogeochemical cycles, *Science*, 250, 1669, 1990.
  87. Crutzen, P.J., A.C. Delany, J. Greenberg, P. Haagenson, L. Heidt, R. Lueb, W. Pollock, W. Seiler, A. Warthurg and P. Zimmerman, Tropospheric chemical composition measurements in Brazil during the dry season, *J. Atmos. Chem.*, 2, 233, 1985.
  88. Amazon Boundary Layer Experiment (ABLE 2A): Dry season 1985, Collection of 24 papers, *J. Geophys. Res.*, 93 (D2), 1349-1624, 1988.
  89. Andreae, M.O. et al., Biomass burning emissions and associated haze layers over Amazonia, *J. Geophys. Res.*, 93, 1509, 1988.
  90. Andreae, M.O. et al., Ozone and Aitken nuclei over equatorial Africa: Airborne observations during DECAFE 88, *J. Geophys. Res.*, 97, 6137, 1992.
  91. Fishman, J., K. Fakhruzzaman, B. Cros and D. Nyanga, Identification of widespread pollution in the southern hemisphere deduced from satellite analyses, *Science*, 252, 1693, 1991.
  92. FOS/DECAFE 91 Experiment, Collection of 13 papers in *J. Atmos. Chem.*, 22, 1-239, 1995.
  93. Fishman, J., Probing planetary pollution from space, *Environ. Sci. Technol.*, 25, 612, 1991.
  94. Connors, V., M. Flood, T. Jones, B. Gormsen, S. Nolt and H. Reichle, Global distribution of biomass burning and carbon monoxide in the middle troposphere during early April and October 1994, in *Biomass Burning and Global Change* (J. Levine, Ed.), MIT Press, 1996 (in press).
  95. Foley, H.M. and M.A. Ruderman, Stratospheric NO production from past nuclear explosions, *J. Geophys. Res.*, 78, 4441, 1973.
  96. Johnston, H.S., G. Whitten and J.W. Birks, Effects of nuclear explosions on stratospheric nitric oxide and ozone, *J. Geophys. Res.*, 78, 6107, 1973.
  97. Crutzen, P.J. and J. Birks, The atmosphere after a nuclear war: Twilight at noon, *Ambio*, 12, 114, 1982.
  98. Turco, R.P., O.B. Toon, R.P. Ackerman, H.B. Pollack and C. Sagan, Nuclear winter: Global consequences of multiple nuclear explosion, *Science*, 222, 1283, 1983.
  99. Thompson, S.L., V. Alexandrov, G.L. Stenchikov, S.H. Schneider, C. Covey and R.M. Chervin, Global climatic consequences of nuclear war: Simulations with three-dimensional models, *Ambio*, 13, 236, 1984.
  100. Pittock, A.B., T.P. Ackerman, P.J. Crutzen, M.C. MacCracken, C.S. Shapiro and R.P. Turco, *Environmental Consequences of Nuclear War. Volume I: Physical and Atmospheric Effects*, SCOPE 28, Wiley, 1986.
  101. Harwell, M.A. and T.C. Hutchinson, *Environmental Consequences of Nuclear War. Volume II: Ecological and Agricultural Effects*, SCOPE 28, Wiley, 1985.

102. Lelieveld, J. and P.J. Crutzen, Influences of cloud photochemical processes on tropospheric ozone, *Nature*, 343, 227, 1990.
103. Dentener, F.J. and P.J. Crutzen, Reaction of  $N_2O_3$  on tropospheric aerosols: Impact on the global distributions of  $NO_x$ ,  $O_3$ , and OH, *J. Geophys. Res.*, 98 (D14), 7149, 1993.
104. Chatfield, R. and P.J. Crutzen, Sulfur dioxide in remote oceanic air: Cloud transport of reactive precursors, *J. Geophys. Res.*, 89 (D5), 711, 1984.
105. Lelieveld, J. and P.J. Crutzen, Role of deep convection in the ozone budget of the troposphere, *Science*, 264, 1759, 1994.
106. Barrie, L.A., J.W. Bottenheim, R.C. Schnell, P.J. Crutzen and R.A. Rasmussen, Ozone destruction and photochemical reactions at polar sunrise in the lower Arctic atmosphere, *Nature*, 334, 138, 1988.
107. Sander, R. and P.J. Crutzen, Model study indicating halogen activation and ozone destruction in polluted air masses transported to the sea, *J. Geophys. Res.* 101, 9121, 1996.
108. Vogt, R., P.J. Crutzen and R. Sander, A new mechanism for bromine and chlorine release from sea salt aerosol in the unpolluted marine boundary layer, *Nature* (submitted).
109. Crutzen, P.J., Overview of tropospheric chemistry: Developments during the past quarter century and a look ahead, *Faraday Discuss.* 100, 1, 1995.
110. Khalil, M.A.K. and R.A. Rasmussen, Global decrease of atmospheric carbon monoxide, *Nature*, 370, 639, 1993.
111. Novelli, P.C., K.A. Masario, P.P. Tans and P.M. Lang, Recent changes in atmospheric carbon monoxide, *Science*, 263 1587, 1994.
112. Zander, R., Ph. Demoulin, D.H. Ehhalt, U. Schmidt and C.P. Rinsland, Secular increases in the total vertical abundances of carbon monoxide above central Europe since 1950, *J. Geophys. Res.*, 94, 11021, 1989.
113. Zander, R., Ph. Demoulin, D.H. Ehhalt and U. Schmidt, Secular increases of the vertical abundance of methane derived from IR solar spectra recorded at the Jungfraujoch station, *J. Geophys. Res.*, 94, 11029, 1989.
114. Crutzen, P.J., Global tropospheric chemistry, in *Low-Temperature Chemistry of the Atmosphere* (G.K. Moortgat et al., Eds), Springer, Berlin, pp 467-498, 1994.
115. Crutzen, P.J., Ozone in the Troposphere, in *Composition, Chemistry and Climate of the Atmosphere* (H.B. Singh, Ed.), Von Nostrand Reinhold, New York, 349-393, 1995.
116. Kley, D., H.G.J. Smit, H. Vömel, S. Oltmans, H. Grassl, V. Ramanathan and P.J. Crutzen, Extremely low upper tropospheric ozone observations in the convective regions of the Pacific, *Science* (submitted).
117. Ramanathan, V., B. Subasilar, G.J. Zhang, W. Conant, R.D. Cess, J.T. Kiehl, H. Grassl and L. Shi, Warm pool heat budget and shortwave cloud forcing: a missing physics? *Science*, 267, 499, 1995.
118. Hausmann, M. and U. Platt, Spectroscopic measurement of bromine oxide and ozone in the high Arctic during Polar Sunrise Experiment 1992, *J. Geophys. Res.*, 99, 25399, 1994.
119. Oltmans, S.J. and D.J. Hofmann, Increase in lower-stratospheric water vapour at a mid-latitude northern hemisphere site from 1981 to 1994, *Nature*, 374, 146, 1995.
120. Crutzen, P.J., J.U. Groöb, C. Brühl, R. Müller and J.M. Russell III, A reevaluation of the ozone budget with HALOE UARS data: No evidence for the ozone deficit, *Science*, 268, 705, 1995.



## PUBLICATIONS

*Books*

- Crutzen, P.J. and J. Hahn, 1985: *Schwarzer Himmel*. S. Fischer Verlag, 240 pp.
- Pittock, A.B., T.P. Ackerman, P.J. Crutzen, M.C. MacCracken, C.S. Shapiro and R.P. Turco, 1986: *Environmental Consequences of Nuclear War*, SCOPE 28, Volume I: Physical and Atmospheric Effects, Wiley, Chichester, 359 pp; 2nd edition 1989.
- Crutzen P.J. and M. Müller, 1989: *Das Ende des blauen Planeten?* C.H. Beck Verlag, 271 pp.
- Enquete Commission "Preventive Measures to Protect the Earth's Atmosphere", 1989: Interim Report: *Protecting the Earth's atmosphere: an International Challenge*. Ed. Deutscher Bundestag, Referat Öffentlichkeitsarbeit, Bonn, 592 pp.
- Enquete Commission "Preventive Measures to Protect the Earth's Atmosphere", 1990: *Protecting the Tropical Forests A High-Priority international Task*. Ed. Deutscher Bundestag, Referat Öffentlichkeitsarbeit, Bonn, 968 pp.
- Enquete Commission "Preventive Measures to Protect the Earth's Atmosphere", 1991: *Protecting the Earth: A Status Report with Recommendations for a new Energy Policy*. Ed. Deutscher Bundestag, Referat Öffentlichkeitsarbeit, Bonn, 2 Volumes.
- Crutzen, P.J., J.-C. Gerard and R. Zander (Eds.), 1989: *Our Changing Atmosphere*. Proceedings of the 28th Liege International Astrophysical Colloquium June 26-30, 1989, Université de Liège, Cointe-Ougree, Belgium, 534 pp.
- Graedel, T.E. and P.J. Crutzen, 1993: *Atmospheric Change: An Earth System Perspective*. W.H. Freeman, New York, 446 pp.
- Crutzen, P.J. and J.G. Goldammer, 1993: *Fire in the Environment: The Ecological, Atmospheric, and Climatic Importance of Vegetation Fires*. Dahlem Konferenz (15-20 March 1992, Berlin), ES13, Wiley, Chichester, 400 pp.
- Graedel, T.E. and P.J. Crutzen, 1994: *Chemie der Atmosphäre. Bedeutung für Klima und Umwelt*. Spektrum-Verlag, Heidelberg, 511 pp.
- Graedel, T.E. and P.J. Crutzen, 1995: *Atmosphere, Climate, and Change*. W.H. Freeman, New York, 208 pp.

## JOURNAL ARTICLES (REFEREED):

- Blankenship, J.R. and P.J. Crutzen, 1965: A photochemical model for the space-time variations of the oxygen allotropes in the 20 to 100 km layer. *Tellus*, **18**, 160-175.
- Crutzen, P.J., 1969: Determination of parameters appearing in the "dry" and the "wet" photochemical theories for ozone in the stratosphere. *Tellus*, **21**, 368-388.
- Crutzen, P.J., 1969: Determination of parameters appearing in the oxygen-hydrogen atmosphere. *Ann. Geophys.*, **25**, 275-279.
- Crutzen, P.J., 1970: The influence of nitrogen oxides on the atmospheric ozone content. *Quart. J. Roy. Meteor. Soc.*, **96**, 320-325.
- Crutzen, P.J., 1970: Comments on "Absorption and emission by carbon dioxide in the mesosphere". *Quart. J. Roy. Meteor. Soc.*, **96**, 767-769.
- Crutzen, P.J., 1971: Energy conversions and mean vertical motions in the high latitude summer mesosphere and lower thermosphere. In *Mesospheric Models and Related Experiments*, G. Fiocco, (ed.), D. Reidel Publ. Co., Dordrecht, Holland, 78-88.
- Crutzen, P.J., 1971: Calculation of  $O_3(^1\Delta_g)$  in the atmosphere using new laboratory data. *J. Geophys. Res.*, **76**, 1490-1497.
- Crutzen, P.J., 1971: Ozone production rates in an oxygen-hydrogen-nitrogen oxide atmosphere. *J. Geophys. Res.*, **76**, 7311-7327.
- Crutzen, P.J., 1972: SST's-a threat to the earth's ozone shield. *Ambio*, **1**, 41-51.
- Crutzen, P.J., 1973: A discussion of the chemistry of some minor constituents in the stratosphere and troposphere. *Pure App. Geophys.*, **106-108**, 1385-1399.
- Crutzen, P.J., 1973: Gas-phase nitrogen and methane chemistry in the atmosphere. In *Physics and Chemistry of Upper Atmospheres*, B.M. McCormac (rd.), Reidel, Dordrecht, Holland, 110-124.
- Crutzen, P.J., 1974: A review of upper atmospheric photochemistry. *Can. J. Chem.*, **52**, 1569-1581.

13. Crutzen, P.J., 1974: Estimates of possible future ozone reductions from continued use of fluorochloromethanes (CF<sub>2</sub>Cl<sub>2</sub>, CFCl<sub>3</sub>) *Geophys. Res. Lett.*, **1**, 205-208.
14. Crutzen, P.J., 1974: Estimates of possible variations in total ozone due to natural causes and human activities. *Ambio*, **3**, 201-210.
15. Crutzen, P.J., 1974: Photochemical reactions initiated by and influencing ozone in unpolluted tropospheric air. *Tellus*, **26**, 48-57.
16. Cadle, R.D., P.J. Crutzen and D.H. Ehhalt, 1975: Heterogeneous chemical reactions in the Stratosphere. *J. Geophys. Res.*, **80**, 3381-3385.
17. Crutzen, P.J., I.S.A. Isaksen and G.C. Reid, 1975: Solar proton events: stratospheric sources of nitric oxide. *Science*, **189**, 457-459.
18. Johnston, H.S., D. Garvin, M.L. Corrin, P.J. Crutzen, R.J. Cvetanovic, D.D. Davis, E.S. Domalski, E.E. Ferguson, R.F. Hampson, R.D. Hudson, L.J. Kieffer, H.I. Schiff, R.L. Taylor, D.D. Wagman and R.T. Watson, 1975: Chemistry in the stratosphere, Chapter 5, *CIAP Monograph I. The Natural Stratosphere of 1974*, DOT-TST-75-51, U.S. Department of Transportation, Climate Impact Assessment Program.
19. Schmeltekopf, A.L., P.D. Goldan, W.R. Henderson, W.J. Harrop, T.L. Thompson, F.C. Fehsenfeld, H.I. Schiff, P.J. Crutzen, I.S.A. Isaksen and E.E. Ferguson, 1975: Measurements of stratospheric CFCl<sub>3</sub>, CF<sub>2</sub>Cl<sub>2</sub>, and N<sub>2</sub>O. *Geophys. Res. Lett.*, **2**, 393-396.
20. Zerefos, C.S. and P.J. Crutzen, 1975: Stratospheric thickness variations over the northern hemisphere and their possible relation to solar activity *J. Geophys. Res.*, **80**, 5041-5043.
21. Crutzen, P.J., 1976: Upper limits on atmospheric ozone reductions following increased application of fixed nitrogen to the soil. *Geophys. Res. Lett.*, **3**, 169-172.
22. Crutzen, P.J., 1976: The possible importance of CSO for the sulfate layer of the stratosphere. *Geophys. Res. Lett.*, **3**, 73-76.
23. Crutzen, P.J. and D.H. Ehhalt, 1977: Effects of nitrogen fertilizers and combustion on the stratospheric ozone layer. *Ambio*, **6**, 1-3, 112-117.
24. Crutzen, P.J. and G.C. Reid, 1976: Comments on "Biotic extinctions by solar flares". *Nature*, **263**, 259.
25. Fehsenfeld, F.C., P.J. Crutzen, A.L. Schmeltekopf, C.J. Howard, D.L. Albritton, E.E. Ferguson, J.A. Davidson and H.I. Schiff, 1976: Ion chemistry of chlorine compounds in the troposphere and stratosphere. *J. Geophys. Res.*, **81**, 4454-4460.
26. Reid, G.C., I.S.A. Isaksen, T.E. Holzer and P.J. Crutzen, 1976: Influence of ancient solar proton events on the evolution of life. *Nature*, **259**, 177-179.
27. Crutzen, P.J. and J. Fishman, 1977: Average concentrations of OH in the troposphere, and the budgets of CH<sub>4</sub>, CO, H<sub>2</sub> and CH<sub>2</sub>Cl<sub>2</sub>. *Geophys. Res. Lett.*, **4**, 321-324.
28. Fishman, J. and P.J. Crutzen, 1977: A numerical study of tropospheric photochemistry using a one-dimensional model. *J. Geophys. Res.*, **82**, 5897-5906.
29. Heath, D.F., A.J. Krueger and P.J. Crutzen, 1977: Solar proton event: influence on stratospheric ozone. *Science*, **197**, 886-889.
30. Hidalgo, H. and P.J. Crutzen, 1977: The tropospheric and stratospheric composition perturbed by NO<sub>x</sub> emissions of high altitude aircraft. *J. Geophys. Res.*, **82**, 5833-5866.
31. Isaksen, I.S.A. and P.J. Crutzen, 1977: Uncertainties in calculated hydroxyl radical densities in the troposphere and stratosphere. *Geophysica Norvegica*, **31**, 4, 1-10.
32. Isaksen, I.S.A., K.H. Midtboe, J. Sunde and P.J. Crutzen, 1977: A simplified method to include molecular scattering and reflection in calculations of photon fluxes and photo-dissociation rates. *Geophysica Norvegica*, **31**, 11-26.
33. Schmeltekopf, A.L., D.L. Albritton, P.J. Crutzen, D. Goldan, W.J. Harrop, W.R. Henderson, J.R. McAfee, M. McFarland, H.I. Schiff, T.L. Thompson, D.J. Hofmann and N.T. Kjøme, 1977: Stratospheric nitrous oxide altitude profiles at various latitudes. *J. Atmos. Sci.*, **34**, 729-736.
34. Crutzen, P.J. and C.J. Howard, 1978: The effect of the HO<sub>2</sub> + NO reaction rate constant on one-dimensional model calculations of stratospheric ozone perturbations. *Pure Appl. Geophys.*, **116**, 487-510.
35. Crutzen, P.J., I.S.A. Isaksen and J.R. McAfee, 1978: The impact of the chlorocarbon industry on the ozone layer. *J. Geophys. Res.*, **83**, 345-363.

36. Fishman, J. and P.J. Crutzen, 1978: The origin of ozone in the troposphere. *Nature*, 274, 855-858.
37. Reid, G.C., J.R. McAfee and P.J. Crutzen, 1978: Effects of intense stratospheric ionization events. *Nature*, 257, 489-492.
38. Zimmerman, P.R., R.B. Chatfield, J. Fishman, P.J. Crutzen and P.L. Hanst, 1978: Estimates on the production of CO and H<sub>2</sub> from the oxidation of hydrocarbon emissions from vegetation. *Geophys. Res. Lett.*, 5, 679-682.
39. Crutzen, P.J., 1979: The role of NO and NO<sub>2</sub> in the chemistry of the troposphere and stratosphere. *Ann. Rev. Earth Planet. Sci.*, 7, 443-472.
40. Crutzen, P.J., 1979: Chlorofluoromethanes: threats to the ozone layer. *Rev. Geophys. Space Phys.*, 17, 1824-1832.
41. Crutzen, P.J., L.E. Heidt, J.P. Krasnec, W.H. Pollock and W. Seiler, 1979: Biomass burning as a source of atmospheric gases CO, H<sub>2</sub>, N<sub>2</sub>O, NO, CH<sub>3</sub>Cl and COS. *Nature* 282 253-256.
42. Dickerson, R.R., D.H. Stedman, W.L. Chameidcs, P.J. Crutzen and J. Fishman, 1979: Actinometric measurements and theoretical calculations of J(O<sub>3</sub>), the rate of photolysis of ozone to O(1D) *Geophys. Res. Lett.*, 6, 833-836.
43. Fishman, J., V. Ramanathan, P.J. Crutzen and S.C. Liu, 1979: Tropospheric ozone and climate. *Nature*, 282, 81X-820.
44. Fishman, J., S. Solomon and P.J. Crutzen, 1979: Observational and theoretical evidence in support of a significant in situ photochemical source of tropospheric ozone. *Tellus*, 31, 432-446.
45. Berg, W.W., P.J. Crutzen, F.E. Grahek, S.N. Gitlin and W.A. Sedlacek, 1980: First measurements of total chlorine and bromine in the lower stratosphere. *Trophy. Res. Lett.*, 7, 937-940
46. Crutzen, P.J. and S. Solomon, 1980: Response of mesospheric ozone to particle precipitation. *Planet. Space Sci.*, 28, 1147-1 153.
47. Heidt, L.E., J.P. Krasnec, R.A. Lueb, W.H. Pollock, B.E. Henry and P.J. Crutzen, 1980: Latitudinal distributions of CO and CH<sub>4</sub> over the Pacific. *J Geophys. Res.*, 85, 7329-7336.
48. Seiler, W. and P.J. Crutzen, 1980: Estimates of gross and net fluxes of carbon between the biosphere and the atmosphere from biomass burning. *Climatic Change*, 2, 207-247
49. Thomas, G.E., C.A. Barth, E.R. Hansen, C.W. Hord, G.M. Lawrence, G.H. Mount, G.J. Rottman, D.W. Rurch, A.I. Stewart, R.J. Thomas, J. London, P.L. Bailey, P.J. Crutzen, R.E. Dickinson, J.C. Gille, S.C. Liu, J.F. Noxon and C.B. Farmer, 1980: Scientific Objectives of the Solar- Mesosphere Explorer Mission. *Pure Appl. Geophys.*, 118, 591-615.
50. Rodhe, H., P. Crutzen and A. Vanderpol, 1981: Formation of sulfuric acid in the atmosphere during long range transport. *Tellus*, 33, 132-141.
51. Rusch, D.W. J.(Z. Gérard, S. Solomon, P.J. Crutzen and G.C. Reis, 1981: The effects of particle precipitation events on the neutral and ion chemistry of the middle atmosphere-1. Odd Nitrogen. *Planet Space Sci.*, 29, 767-774.
52. Solomon, S. and P.J. Crutzen, 1981: Analysis of the August 1972 solar proton event including chlorine chemistry.//. *Geophys. Res.*, 86, 1140-1 146.
53. Solomon, S., D.W. Rusch, J.C. Gérard, G.C. Reid and P.J. Crutzen, 1981: The effect of particle precipitation events on the neutral and ion chemistry of the middle atmosphere-11. Odd Hydrogen. *Planet Space Sri.*, 29, 885-892.
54. Baulch, D.L., R.A. Cox, P.J. Crutzen, R.F. Hampson Jr., J.A. Kerr and J. Troe, 1982: Evaluated kinetic and photochemical data for atmospheric chemistry: Supplement 1. *J. Phys. Chem. Ref. Data*. 11, 327-496.
55. Crutzen, P.J., 1982: The global distribution of hydroxyl. In: *Atmospheric Chemistry*, ed. E.D. Goldberg, pp. 313-328. Dahlem Konferenzen 1982. Berlin, Heidelberg, New York: Springer-Verlag.
56. Crutzen, P.J. and J.W. Birks, 1982: The atmosphere after- a nuclear war: Twilight at Noon. *A&O*, 2&3, 114-125.
57. Hahn, J. and P.J. Crutzen, 1982: The role of fixed nitrogen in atmospheric photochemistry. *Phil. Trans. li. Soc. Lond.*, B 296, 521-541.

58. Solomon, S., P.J. Crutzen and R.G. Roble, 1982: Photochemical coupling between the thermosphere and the lower atmosphere. 1. Odd nitrogen from 50-120 km. *J. Geophys. Res.*, 87, 7206-7220.
59. Solomon, S., E.E. Ferguson, D.W. Fahey and P.J. Crutzen, 1982: On the chemistry of H<sub>2</sub>O, H<sub>2</sub> and meteoritic ions in the mesosphere and lower thermosphere. *Planet. Space Sci.*, 30, 1117-1126.
60. Solomon, S., G.C. Reid, R.G. Roble and P.C. Crutzen, 1982: Photochemical coupling between the thermosphere and the lower atmosphere. 2. D-region ion chemistry and the winter anomaly. *J. Geophys. Res.*, 87, 7221-7227.
61. Zimmerman, P.R., J.P. Greenberg, S.O. Wandiga and P.J. Crutzen, 1982. Termites: A Potentially Large Source of Atmospheric Methane, Carbon Dioxide, and Molecular Hydrogen. *Science*, 218, 563-565.
62. Bolin, B., P.J. Crutzen, P.M. Vitousek, R.G. Woodmansee, E.D. Goldberg and R.B. Cook, 1983: Interactions of biochemical cycles, in: B. Bolin and R.B. Cook, Eds: *The Major Biochemical Cycles and Their Interactions*, SCOPE 21, pp. 1-40, Wiley, Chichester.
63. Crutzen, P.J., 1983: Atmospheric interactions-homogeneous gas reactions of C, N, and S containing compounds, in: B. Bolin and R.B. Cook, Eds.: *The Major Biochemical Cycles and Their Interactions*, SCOPE 21, pp. 67-114, Wiley, Chichester.
64. Crutzen, P.J. and L.T. Gidel, 1983: A two-dimensional photochemical model of the atmosphere. 2. The tropospheric budgets of the anthropogenic chlorocarbons, CO, CH<sub>4</sub>, CH<sub>3</sub>Cl and the effect of various NO<sub>x</sub> sources on tropospheric ozone. *J. Geophys. Res.*, 88, 6641-6661.
65. Crutzen, P.J. and U. Schmailzl, 1983: Chemical budgets of the stratosphere. *Planet. Space Sci.*, 31, 1009-1032.
66. Frederick, J.E., R.B. Abrams and P.J. Crutzen, 1983: The Delta Band Dissociation of Nitric Oxide: A Potential Mechanism for Coupling Thermospheric Variations to the Mesosphere and Stratosphere. *J. Geophys. Res.*, 88, 3829-3925.
67. Gidel, L.T., P.J. Crutzen and J. Fishman, 1983: A two-dimensional photochemical model of the atmosphere. 1: Chlorocarbon emissions and their effect on stratospheric ozone. *J. Geophys. Res.*, 88, 6622-6640.
68. Chatfield, R.B. and P.J. Crutzen, 1984: Sulfur Dioxide in Remote Oceanic Air: Cloud Transport of Reactive Precursors. *J. Geophys. Res.*, 89 (D5), 7111-7132.
69. Crutzen, P.J., I.E. Galbally and C. Brühl, 1984: Atmospheric Effects from Postnuclear fires. *Climatic Change*, 6, 323-364.
70. Crutzen, P.J., M.T. Coffey, A.C. Delany, J. Greenberg, P. Haagenson, L. Heidt, R. Heidt, L. Lueb, W.G. Mankin, W. Pollock, W. Seiler, A. Warthurg and P. Zimmerman, 1985: Observations of air composition in Brazil between the equator and 20°S during the dry season. *Acta Amazonica*, Manaus, 15(1-2): 77-119.
71. Crutzen, P.J., A.C. Delany, J. Greenberg, P. Haagenson, L. Heidt, R. Lueb, W. Pollock, W. Seiler, A. Warthurg and P. Zimmerman, 1985: Tropospheric Chemical Composition Measurements in Brazil During the Dry Season. *J. Atmos. Chem.*, 2, 233-256.
72. Crutzen, P.J., D.M. Whelpdale, D. Kley and L.A. Barrie, 1985: The cycling of sulfur and nitrogen in the remote atmosphere, in: *The Biogeochemical Cycling of Sulfur and Nitrogen in the Remote Atmosphere* (J.N. Galloway, R.J. Charlson, M.O. Andreae and H. Rodhe, Eds.), NATO ASI Series C 158, Reidel, Dordrecht, Holland, 203-212.
73. Delany, A.C., P. Haagenson, S. Walters, A.F. Warthurg and P.J. Crutzen, 1985: Photochemically produced ozone in the emission of large scale tropical vegetation fires. *J. Geophys. Res.*, 90 (D1), 2425-2429.
74. Crutzen, P.J. and F. Arnold, 1986: nitric acid cloud formation in the cold Antarctic stratosphere: a major cause for the springtime "ozone hole". *Nature*, 324, 651-655.
75. Crutzen, P.J., I. Aselmann and W. Seiler, 1986: Methane production by domestic animals, wild ruminants, other herbivorous fauna, and humans. *Tellus*, 38B, 271-284.
76. Crutzen, P.J. and T.E. Graedel, 1986: The role of atmospheric chemistry in environment-development interactions, in *Sustainable Development Of the Environment* (W.C. Clark and R.E. Munn, Eds.), Cambridge University Press, 213-251.
77. Bingemer, H.G. and P.J. Crutzen, 1987: The production of methane from solid wastes. *J. Geophys. Res.*, 92 (D2), 2181-2187.

78. Crutzen, P.J., 1987: Role of the tropics in the atmospheric chemistry, in: R. Dickinson, Ed: *Geophysiology of the Amazon*, Wiley, Chichester-New York, 107-131,
79. Crutzen, P.J., 1987: Acid rain at the K/T boundary, *Nature*, **330**, 108-109.
80. Barrie, L.A., J.W. Bottenheim, R.C. Schnell, P.J. Gutzen and R.A. Rasmussen, 1988: Ozone destruction and photochemical reactions at polar sunrise in the lower Arctic atmosphere. *Nature*, **334**, 138-141.
81. Briihl, C. and P.J. Crutzen, 1988: Scenarios of possible changes in atmospheric temperatures and ozone concentrations due to man's activities as estimated with a one-dimensional coupled photochemical climate model. *Climate Dynamics* **2**, 173-203.
82. Crutzen, P.J., 1988: Tropospheric ozone: an Overview pp. in: *Tropospheric Ozone*, I.S.A. Isdksen Ed., Reidel, Dordrecht, 3-32.
83. Crutzen, P.J., 1988: Variability in Atmospheric-Chemical Systems, in: *Scales and Global Change*, SCOPE 3.5, T. Rosswall R.G. Woodmansee and P.G. Risser, Eds., Wiley, Chichester, 81-108.
84. Crutzen, P.J., C. Briihl, U. Schmailzl and F. Arnold, 1988: Nitric acid haze formation in the lower stratosphere: a major contribution factor to the development of the Antarctic "ozone hole", in *Aerosols and Climate* (M.P. McCormick and P.V. Hobbs, Editors), A. Deepak Publ., Hampton, Virginia, USA, pp. 287-304.
85. Hao, W.M., D. Scharffe, E. Sanhueela and P.J. Crutzen, 1988: Production of N<sub>2</sub>O, CH<sub>4</sub>, and CO<sub>2</sub> from Soils in the Tropical Savanna During the Dry Season. *J. Atmos. Chem.*, **7**, 93-105.
86. Horowitz, A., G. von Helden, W. Schneider, P.J. Crutzen and G.K. Moortgar, 1988: Ozone generation in the 214 nm photolysis of oxygen at 25°C. *J. Phys. Chem.*, **92**, 4956-4960.
87. Liu, S.C., R.A. Cox, P.J. Crutzen, D.H. Ehhalt, R. Guicherit, A. Hofzumahaus, D. Kley, S.A. Penkett, L.F. Phillips, D. Poppr and ES. Rowland, 1988: Group Report: Oxidizing Capacity of the atmosphere, in: *The Changing Atmosphere*, F.S. Rowland and I.S.A. Isakuen, Eds., Wiley, Chichester, p. 219-232.
88. Wilson, S.R., P.J. Crutzen, G. Schuster, D.W.T. Griffith and G. Helas, 1988: Phosgene measurements in the upper troposphere and lower stratosphere. *Nature*, **334**, 6X9-691.
89. Aselmann, I. and P.J. Crutzen, 1989: Global distribution of natural freshwater wetlands and rice paddies, their net primary productivity, seasonality and possible methane emission. *J. Atmos. Chem.*, **8**, 307-358.
90. Briihl, C. and P.J. Crutzen, 1989: On the disproportionate role of tropospheric ozone as a filter against solar UV-B radiation. *Geophys. Res. Lett.*, **16**, 703-706.
91. Crutzen, P.J. and C. Briihl, 1989: The impact of observed changes in atmospheric composition on global atmospheric chemistry and climate, in: *The Environmental Record in Glaciers and Ice Sheets*, Dahlem Konferenzen 1988, H. Oeschger and C.C. Langway, Eds., Wiley, Chichester, pp. 249-266.
92. Pearman, G.I., R.J. Charlson, T. Class, H.B. Clausen, P.J. Crutzen, T. Hughes, D.A. Peel, K.A. Rahn, J. Rudolph, U. Siegenthaler and D.S. Zardini, 1989: Group Report: What Anthropogenic Impacts are recorded in Glaciers? In: Dahlem Workshop Reports: *The Environmental Record in Glaciers and Ice Sheets*, Dahlem Konferenzen, H. Oeschger and C.C. Langway, Eds., Wiley, Chichester, pp. 269-286.
93. Robertson, R.P., M.O. Andreae, H.G. Bingemer, P.J. Crutzen, R.A. Delmas, J.H. Duizer, I. Fung, R.C. Harriss, M. Kanakidou, M. Keller, J.M. Melillo and G.A. Zavarzin, 1989: Group Report: Trace gas exchange and the chemical and physical climate: Critical interactions, In: Dahlem Workshop Reports: *Exchange of Trace Gases between Terrestrial Ecosystems and the Atmosphere*, Eds. M.O. Andreae and D.S. Schimel, Life Sciences Research Report 47, Wiley, Chichester, pp. 303-320.
94. Simon, F.G., J.P. Burrows, W. Schneider, G.K. Moortgat and P.J. Crutzen, 1989: Study of the reaction ClO + CH<sub>2</sub>O<sub>2</sub> → Products at 300 K. *J Phys. Chem.*, **93**, 7807-7813.
95. Zimmermann, P.H., H. Feichter, H.K. Rath, P.J. Crutzen and W. Weiss, 1989: A global three-dimensional source-receptor model investigating <sup>85</sup>Kr. *Atmos. Environ.* **23**, 25-35.
96. Briihl, C. and P.J. Crutzen, 1990: Ozone and climate changes in the light of the Montreal Protocol, a model study. *Ambio*, **19**, 293-301.

97. Chatfield, R.B. and P.J. Crutzen, 1990: Are there interactions of iodine and sulfur species in marine air photochemistry? *J. Geophys. Res.*, **95**, 22319-22341.
98. Crutzen, P.J. and M.O. Andreae, 1990: Biomass burning in the tropics: impact on atmospheric chemistry and biogeochemical cycles. *Science*, **250**, 1669-1678.
99. Feichter, J. and P.J. Crutzen, 1990: Parameterization of vertical tracer transport due to deep cumulus convection in a global transport model and its evaluation with <sup>222</sup>Rn measurements. *Tellus* **42B**, 100-117.
100. Graedel, T.E. and P.J. Crutzen, 1990: Atmospheric trace constituents, in: *The Earth as Transformed by Human Action*, Eds. B.L. Turner II et al., Cambridge University Press, pp. 295-311.
101. Hao, W.M., M.H. Liu and P.J. Crutzen, 1990: Estimates of annual and regional releases of CO<sub>2</sub> and other trace gases to the atmosphere from fires in the tropics, based on the FAO statistics for the period 1975-1980, in: *Fire in the Tropical Biota, Ecological Studies*, **84**, J.G. Goldammer, Ed., Springer-Verlag, Berlin, 440-462.
102. Lelieveld, J. and P.J. Crutzen, 1990: Influence of cloud and photochemical processes on tropospheric ozone. *Nature*, **343**, 227-233.
103. Lobert, J.M., D.H. Scharffe, W.M. Hao and P.J. Crutzen, 1990: Importance of biomass burning in the atmospheric budgets of nitrogen-containing gases. *Nature*, **346**, 552-554.
104. Sanhueza, E. W.M. Hao, D. Scharffe, L. Donoso and P.J. Crutzen, 1990: N<sub>2</sub>O and NO emissions from soils of the northern part of the Guayana Shield, Venezuela. *J. Geophys. Res.*, **95** (D13), 22481-22488.
105. Scharffe, D. W.M. Hao, L. Donoso, P.J. Crutzen and E. Sanhueza, 1990: Soil fluxes and atmospheric concentrations of CO and CH<sub>4</sub> in the northern part of the Guayana Shield, Venezuela. *J. Geophys. Res.*, **95** (D13), 22475-22480.
106. Crutzen, P.J. and P.H. Zimmermann, 1991: The changing photochemistry of the troposphere. *Tellus*, **43 A/B**, 136-151.
107. Hao, W.M., D. Scharffe, J.M. Lobert and P.J. Crutzen, 1991: Emissions of N<sub>2</sub>O from the burning of biomass in an experimental system. *Geophys. Res. Lett.*, **18**, 999-1002.
108. Kanakidou, M., H.B. Singh, K.M. Valentin and P.J. Crutzen, 1991: A 2-D study of ethane and propane oxidation in the troposphere. *J. Geophys. Res.*, **96**, 15395-15413.
109. Kuhlbusch, A.T., J.M. Lobert, P.J. Crutzen and P. Warneck, 1991: Molecular nitrogen emissions from denitrification during biomass burning. *Nature*, **351**, 135-137.
110. Lelieveld, J. and P.J. Crutzen, 1991: The role of clouds in tropospheric photochemistry. *J. Atmos. Chem.*, **12**, 229-267.
111. Lobert, J.M., D.H. Scharffe, W.M. Hao, T.A. Kuhlbusch, R. Seuwen, P. Warneck and P.J. Crutzen, 1991: Experimental evaluation of biomass burning emissions: Nitrogen and carbon containing compounds, in: *Global Biomass Burning: Atmospheric, Climatic and Biosphere Implications*, Ed. J.S. Levine, MIT Press, Cambridge, MA, pp. 122-125.
112. Peter, Th., C. Brühl and P.J. Crutzen, 1991: Increase in the PSC-formation probability caused by high-flying aircraft. *Geophys. Res. Lett.*, **18**, 1465-1468.
113. Crutzen, P.J. and G.S. Golitsyn, 1992: Linkages between Global Warming, Ozone Depletion and Other Aspects of Global Environmental Change, in: *Confronting Climatic Change*, I.M. Mintzer, Ed., pp. 15-32, Cambridge University Press.
114. Crutzen, P.J., R. Müller, Ch. Brühl and Th. Peter, 1992: On the potential importance of the gas phase reaction CH<sub>3</sub>O<sub>2</sub> + ClO → ClOO + CH<sub>3</sub>O and the heterogeneous reaction HOCl + HCl → H<sub>2</sub>O + Cl<sub>2</sub> in "ozone hole" chemistry. *Geophys. Res. Lett.*, **19**, 1113-1116.
115. Kanakidou, M., P.J. Crutzen, P.H. Zimmermann and B. Bonsang, 1992: A 3-dimensional global study of the photochemistry of ethane and propane in the troposphere: Production and transport of organic nitrogen compounds, in: *Air Pollution Modeling and its Implication IX*, H. van Dop and G. Kallos (Eds.), Plenum Press, New York, 41.5-426.
116. Langner, J., H. Rodhe, P.J. Crutzen and P. Zimmermann, 1992: Anthropogenic influence on the distribution of tropospheric sulphate aerosol. *Nature*, **359**, 712-715.
117. Lelieveld, J. and P.J. Crutzen, 1992: Indirect chemical effects of methane on climate warming. *Nature*, **355**, 339-342.

118. Luo, B.P., Th. Peter and P.J. Crutzen, 1992: Maximum supercooling of H<sub>2</sub>SO<sub>4</sub> acid aerosol droplets. *Ber Bunsenges. Phys. Chem.*, **96**, 334-338.
119. Singh, H.B. D. O'Hara, D. Herlth, J.D. Bradshaw, S.T. Sandholm, G.L. Gregory, G.W. Sachse, D.R. Blake, P.J. Crutzen and M. Kanakidou, 1992: Atmospheric measurements of PAN and other organic nitrates at high latitudes: possible sources and sinks. *J. Geophys. Res.*, **97**, 16511-16522.
120. Singh, H.B., D. Herlth, K. Zahnle, D. O'Hara, J. Bradshaw, S.T. Sandholm, R. Talbot, P.J. Crutzen and M. Kanakidou, 1992: Relationship of PAN to active and total odd nitrogen at northern high latitudes: possible influence of reservoir species on NO, and O<sub>3</sub>. *J. Geophys. Res.*, **97**, 16523-16530.
121. Berges, M.G.M., R.M. Hofmann, D. Scharffe and P.J. Crutzen, 1993: Measurement of nitrous oxide emissions from motor vehicles in tunnels. *J. Geophys. Res.*, **98**, 18527-18531.
122. Crutzen, P.J. and C. Brühl, 1993: A model study of atmospheric temperatures and the concentrations of ozone, hydroxyl, and some other photochemically active gases during the glacial, the preindustrial holocene and the present. *Geophys. Res. Lett.*, **20**, 1047-1050.
123. Crutzen, P.J. and G.R. Carmichael, 1993: Modeling the influence of fires on atmospheric chemistry, in: *Fire in the Environment: The Ecological, Atmospheric, and Climatic Importance of Vegetation Fires*, (P.J. Crutzen and J.G. Goldammer, Eds.), op. cit., 90-105.
124. Dentener, F. and P.J. Crutzen, 1993: Reaction of N<sub>2</sub>O<sub>5</sub> on tropospheric aerosols: Impact on the global distributions of NO<sub>x</sub>, O<sub>3</sub> and OH. *J. Geophys. Res.*, **98**, 7149-7163.
125. Goldammer, J.G. and P.J. Crutzen, 1993: Fire in the Environment: Scientific Rationale and Summary of Results of the Dahlem Workshop, in: *Fire in the Environment: The Ecological, Atmospheric and Climatic Importance*, (P.J. Crutzen and J.G. Goldammer, Eds.), op. cit., 1-14.
126. Kanakidou, M. and P.J. Crutzen, 1993: Scale problems in global tropospheric chemistry modeling: Comparison of results obtained with a three-dimensional model, adopting longitudinally uniform and varying emissions of NO<sub>x</sub> and NMHC. *Chemosphere*, **26**, 787-801.
127. Kanakidou, M., F.J. Dentener and P.J. Crutzen, 1993: A global three-dimensional study of the degradation of HCFC's and HFC-134a in the troposphere. Proceedings of STEP-HALOCSIDE/AFEAS Workshop on *Kinetics and Mechanisms for the Reactions of Halogenated Organic Compounds in the Troposphere*, Dublin, Ireland, March 23-25, 1993, Campus Printing Unit, University College Dublin, 113-129.
128. Lelieveld, J., P.J. Crutzen and C. Brühl, 1993: Climate effects of atmospheric methane. *Chemosphere*, **26**, 739-768.
129. Müller, R. and P.J. Crutzen, 1993: A possible role of galactic cosmic rays in chlorine during polar night. *J. Geophys. Res.*, **98**, 20483-20490.
130. Peter, Th. and P.J. Crutzen, 1993: The role of stratospheric cloud particles in Polar ozone depletion. An Overview. *J. Aerosol Sci.*, **24**, **Suppl. 1**, S119-S120.
131. Russell III, J.M., A.F. Tuck, L.L. Gordley, J.H. Park, S.R. Drayson, J.E. Harries, R.J. Cicerone and P.J. Crutzen, 1993: Haloe Antarctic observations in the spring of 1991. *Geophys. Res. Lett.*, **20**, 719-722.
132. Schupp, M., P. Bergamaschi, G.W. Harris and P.J. Crutzen, 1993: Development of a tunable diode laser absorption spectrometer for measurements of the <sup>13</sup>C/<sup>12</sup>C ratio in methane. *Chemosphere*, **26**, 13-22.
133. Carslaw, K.S., B.P. Luo, S.L. Clegg, Th. Peter, P. Brimblecombe and P.J. Crutzen, 1994: Stratospheric aerosol growth and HNO<sub>3</sub> gas phase depletion from coupled HNO<sub>3</sub> and water uptake by liquid particles. *Geophys. Res. Lett.*, **21**, 2479-2482.
134. Chen, J.-P. and P.J. Crutzen, 1994: Solute effects on the evaporation of ice particles. *J. Geophys. Res.*, **99**, 18847-18859.
135. Cox, R.A., A.R. MacKenzie, R. Müller, Th. Peter and P.J. Crutzen, 1994: Activation of stratospheric chlorine by reactions in liquid sulphuric acid. *Geophys. Res. Lett.*, **21**, 1439-1442.

136. Crowley, J.N., F. Helleis, R. Müller, G.K. Moortgat and P.J. Crutzen, 1994: CH<sub>3</sub>OCl: UV/visible absorption cross sections, J values and atmospheric significance, *J. Geophys. Res.*, **99**, 20683-20688.
137. Crutzen, P.J., 1994: Global Tropospheric Chemistry, Proceedings of the NATO Advanced Study Institute on *Low Temperature Chemistry of the Atmosphere*, Maratea, Italy, August 29-September 11, 1993, NATO ASI Series I, **21** (Eds. G.K. Moortgat et al.), Springer, Heidelberg, 465-498.
138. Crutzen, P.J., 1994: Global budgets for non-CO<sub>2</sub> greenhouse gases, *Environmental Monitoring and Assessment*, **31**, 1-15.
139. Crutzen, P.J., J. Lelieveld and Ch. Brühl, 1994: Oxidation processes in the atmosphere and the role of human activities: Observations and model results, in: *Environmental Oxidants*, J.O. Nriagu and M.S. Simmons (Eds.), Vol. 28 in "Advances in Environmental Science and Technology", Wiley, Chichester, 63-93.
140. Dentener, F.J. and P.J. Crutzen, 1994: A three dimensional model of the global ammonia cycle, *J. Atmos. Chem.* **19**, 331-369.
141. Deshler, T., Th. Peter, R. Müller and P.J. Crutzen, 1994: The lifetime of leewave-induced ice particles in the Arctic stratosphere: I. Balloonborne observations. *Geophys. Res. Lett.*, **21**, 1327-1330.
142. Lelieveld, J. and P.J. Crutzen, 1994: Emissionen klimawirksamer Spurengase durch die Nutzung von Öl und Erdgas. *Energiwirtschaftliche Tagesfragen*, **7**, 435-440.
143. Lelieveld, J. and P.J. Crutzen, 1994: Role of deep cloud convection in the ozone budget of the troposphere, *Science*, **264**, 1759-1761.
144. Luo, B.P., Th. Peter and P.J. Crutzen, 1994: Freezing of stratospheric aerosol droplets. *Geophys. Res. Lett.*, **21**, 1447-1450.
145. Luo, B.P., S.L. Clegg, Th. Peter, R. Müller and P.J. Crutzen, 1994: HCl solubility and liquid diffusion in aqueous sulfuric acid under stratospheric conditions, *Geophys. Res. Lett.*, **21**, 49-52.
146. Müller, R., Th. Peter, P.J. Crutzen, H. Oelhaf, G. Adrian, Th. v. Clarmann, A. Wegner, H. Schmidt and D. Lary, 1994: Chlorine chemistry and the potential for ozone depletion in the Arctic stratosphere in the winter of 1991/92. *Geophys. Res. Lett.*, **21**, 1427-1430.
147. Peter, Th. and P.J. Crutzen, 1994: Modelling the chemistry and micro-physics of the cold stratosphere. Proceedings of the NATO Advanced Study Institute on *low Temperature Chemistry of the Atmosphere* Maratea, Italy, August 29-September 11, 1993, NATO ASI Series I, **21** (Eds. C.K. Moortgat et al.), Springer, Heidelberg, 499-530.
148. Peter, Th., P.J. Crutzen, R. Müller and T. Deshler, 1994: The lifetime of leewave-induced particles in the Arctic stratosphere: II. Stabilization due to NAT-coating. *Geophys. Res. Lett.*, **21**, 1331-1334.
149. Sanhueza, E., L. Donoso, D. Scharffe and P.J. Crutzen, 1994: Carbon monoxide fluxes from natural, managed, or cultivated savannah grasslands, *J. Geophys. Res.*, **99**, 16421-16425.
150. Sassen, K., Th. Peter, B.P. Luo and P.J. Crutzen, 1994: Volcanic Bishop's ring: Evidence for a sulfuric acid tetrahydrate particle aerosol, *Appl. Optics.*, **33**, 4602-4606.
151. Singh, H.B., D. O'Hara, D. Herlth, W. Sachse, D.R. Blake, J.D. Bradshaw, M. Kanakidou and P.J. Crutzen, 1994: Acetone in the atmosphere: Distribution, sources and sinks. *J. Geophys. Res.*, **99**, 1805-1819.
152. Crutzen, P.J., 1995: On the role of CH<sub>4</sub> in Atmospheric chemistry: Sources, sinks and possible reductions in anthropogenic sources. *Ambio*, **24**, 52-55.
153. Crutzen, P.J., 1995: Ozone in the troposphere, in: *Composition, Chemistry, and Climate of the Atmosphere*. H.B. Singh (Ed.), Van Nostrand Reinhold Publ., New York, 349-393.
154. Crutzen, P.J., 1995: The role of methane in atmospheric chemistry and climate, in: *Ruminant Physiology: Digestion, Metabolism, Growth and Reproduction. Proceedings of the Eighth International Symposium on Ruminant Physiology*, Eds. W. v. Engelhardt, S. Leonhard-Marek, G. Breves and D. Giesqcke, Ferdinand Enke Verlag, Stuttgart, 291-315.
155. Crutzen, P.J., J.-U. Grob, C. Brühl, R. Müller, J.M. Russell III, 1995: A reevaluation of the ozone budget with HALOE UARS data: no evidence for the ozone deficit. *Science*, **268**, 705-708.



156. Finkbeiner, M., J.N. Crowley, O. Horie, R. Müller, G.K. Moortgat and P.J. Crutzen, 1995: Reaction between HO<sub>2</sub> and ClO: Product formation between 210 and 300 K. *J. Phys. Chem.*, **99**, 16274-16275.
157. Kanakidou, M., F.J. Dentener and P.J. Crutzen, 1995: A global three-dimensional study of the fate of HCFCs and HFC-134a in the troposphere. *J. Geophys. Res.*, **100**, 18781-18801.
158. Koop, T., U.M. Biermann, W. Raber, B.P. Luo, P.J. Crutzen and Th. Peter, 1995: Do stratospheric aerosol droplets freeze above the ice frost point?. *J. Geophys. Res.*, **22**, 917-920.
159. Kuhlbusch, T.A.J. and P.J. Crutzen, 1995: Toward a global estimate of black carbon in residues of vegetation fires representing a sink of atmospheric CO<sub>2</sub> and a source of O<sub>2</sub>. *Global Biogeochem. Cycles*, **4**, 491-501.
160. Meilinger, S.K., T. Koop, B.P. Luo, T. Huthwelker, K.S. Carslaw, P.J. Crutzen and Th. Peter, 1995: Size-dependent stratospheric droplet composition in lee wave temperature fluctuations and their potential role in PSC freezing. *Geophys. Res. Lett.*, **22**, 3031-3034.
161. Rodhe, H. and P.J. Crutzen, 1995: Climate and CCN, *Nature*, **375**, 111.
162. Sander, R., J. Lelieveld and P.J. Crutzen, 1995: Modelling of the nighttime nitrogen and sulfur chemistry in size resolved droplets of an orographic cloud. *Atmos. Chem.*, **20**, 89-116.
163. Schade, G.W. and P.J. Crutzen, 1995: Emission of aliphatic amines from animal husbandry and their reactions: Potential source of N<sub>2</sub>O and HCN. *J. Atmos. Chem.*, **22**, 319-346.
164. Singh, H.B., M. Kanakidou, P.J. Crutzen and D.J. Jacob, 1995: High concentrations and photochemical fate of oxygenated hydrocarbons in the global troposphere. *Nature*, **378**, 50-54.
165. Vömel, H., S.J. Oltmans, D. Kley and P.J. Crutzen, 1995: New evidence for the stratospheric dehydration mechanism in the equatorial Pacific. *Geophys. Res. Lett.*, **22**, 3235-3238.
166. Wang, C. and P.J. Crutzen, 1995: Impact of a simulated severe local storm on the redistribution of sulfur dioxide. *J. Geophys. Res.*, **100**, 11357-11367.
167. Wang, C., P.J. Crutzen, V. Ramanathan, S.F. Williams, 1995: The role of a deep convective storm over the tropical Pacific Ocean in the redistribution of atmospheric chemical species. *J. Geophys. Res.*, **100**, 11509-11516.
168. Wayne, R.P., P. Biggs, J.P. Burrows, R.A. Cox, P.J. Crutzen, G.D. Hayman, M.E. Jenkin, G. Le Bras, G.K. Moortgat, U. Platt, G. Poulet and R.N. Schindler, 1995: Halogen oxides: Radicals, sources and reservoirs in the laboratory and in the atmosphere. *Atmos. Environ.*, **29**, 2675-2884 (special issue).
169. Crutzen, P.J., 1995: Introductory Lecture. Overview of tropospheric chemistry: Developments during the past quarter century and a look ahead. *Faraday Discuss.* **100**, 1-21.
170. Sander, R. and P.J. Crutzen, 1996: Model study indicating halogen activation and ozone destruction in polluted air masses transported to the sea. *J. Geophys. Res.* **101**, 9121, 1996

IN PRESS

SUBMITTED

171. Berges, M.G.M. and J. Crutzen, 1995 revised 1996: Estimates of global N<sub>2</sub>O emissions from cattle, pig and chicken manure, including a discussion of CH<sub>4</sub> emissions. *J. Atmos. Chem.*
172. Brühl, C., S.R. Drayson, J.M. Russell III, P.J. Crutzen, J.M. McInemey, P.N. Purcell, H. Claude, H. Gernandt, T.I. McGee, I.S. McDemid, M.R. Gunson, 1995: HALOE ozone channel validation. *J. Geophys. Res.*

173. Kuhlbusch, T.A.J., M.O. Andreae, H. Cachier, J.G. Goldammer, J.-P. Lacaux, R. Shea and P.J. Crutzen, 1995: Black carbon formation by savanna fires: Measurements and implications for the global carbon cycle. *J Geophys. Res.*
174. Müller, R., P.J. Crutzen, J.U. Grooß, Ch. Brühl, J.M. Russel and A.F. Tuck, 1994: Chlorine activation and ozone depletion in the Arctic vortex during the winters of 1992 and 1993 observed by the halogen oculation experiment on the Upper Atmosphere Research Satellite. (to be submitted to *J Geophys. Res.*)
175. Bergamaschi, P., C. Brühl, C.A.M. Brenninkmeijer, G. Saueressig, J.N. Crowley, J.U. Grooß, H. Fischer and P.J. Crutzen, 1996: Implications of the large carbon kinetic isotope effect in the reaction  $\text{CH}_4 + \text{Cl}$  for the  $^{13}\text{C}/^{12}\text{C}$  ratio of stratospheric  $\text{CH}_4$ . *Geophys. Res. Lett.*
176. Kley, D., H.G.J. Smit, H. Vömel, S. Oltmans, H. Grassl V. Ramanathan and P.J. Crutzen, 1996: Extremely low upper tropospheric ozone observations in the convective regions of the Pacific. *Science.*
177. Shorter, J.H., J.B. McManus, C.E. Kolb, E.J. Allwine, B.K. Lamb, B.W. Mosher, R.C. Harriss, U. Parchatka, H. Fischer, G.W. Harris and P.J. Crutzen, 1996. *J Atmos. Chem.*
178. Vogt, R. and P.J. Crutzen, 1996: A new mechanism for bromine and chlorine release from sea salt aerosol in the unpolluted boundary layer. *Nature.*

#### OTHER PUBLICATIONS

- A1. Crutzen, P.J., 1969: Koldioxiden och klimatet (Carbon dioxide and climate), *Forskning och Framsteg*, 5, 7-9.
- A2. Crutzen, P.J., 1971: The photochemistry of the stratosphere with special attention given to the effects of NO, emitted by supersonic aircraft, First Conference on CIAP, United States Department of Transportation, 880-88.
- A3. Crutzen, P.J., 1971: On some photochemical and meteorological factors determining the distribution of ozone in the stratosphere: Effects on contamination by NO, emitted from aircraft, Technical Report UDC 551.510.4, Institute of Meteorology, University of Stockholm.
- A4. Crutzen, P.J., 1972: Liten risk för klimatändring (Small risk for climatic change; in Swedish). *Forskning och Framsteg*, 2, 27.
- A5. Crutzen, P.J., 1974: Artificial increases of the stratospheric nitrogen oxide content and possible consequences for the atmospheric ozone, Technical Report UDC 551.510.4:546.2, Institute of Meteorology, University of Stockholm.
- A6. Crutzen, P.J., 1974: Väderforskning med matematik (Weather research with mathematics; in Swedish). *Forskning och Framsteg*, 6, 22-23, 26.
- A7. Crutzen, P.J., 1975: Physical and chemical processes which control the production, destruction and distribution of ozone and some other chemically active minor constituents. *GARP Publications Series 16*, World Meteorological Organization, Geneva, Switzerland.
- A8. Crutzen, P.J., 1975: A two-dimensional photochemical model of the atmosphere below 55 km. In: *Estimates of natural and man-caused ozone perturbations due to NO*, *Proceedings of 4th CZAP Conference*, US. Department of Transportation, Cambridge, DOT-TSC-OST-75-38, T.M. Hard and A.J. Brodrick (eds.), 264-279.
- A9. Crutzen, P.J., 1976: Ozonhöljet tunnas ut: Begränsa spray-gaserna (The ozone shield is thinning: limit the use of aerosol propellants; in Swedish). *Forskning och Framsteg*, 5, 29-35.
- A10. Crutzen, P.J., 1977: The Stratosphere-Meosphere. *Solar Output and Its Variations*, O.R. White (ed.), Colorado Associated University Press, Boulder, Colorado, 13-16.
- All. Crutzen, P.J., J. Fishman, L.T. Gidel and R.B. Chatfield, 1978: Numerical investigations of the photochemical and transport processes which affect halocarbons and ozone in the atmosphere. Annual Summary of Research, Dept. of Atmospheric Science, Colorado State Univ., Fort Collins, CO.
- A12. Fishman, J. and P.J. Crutzen, 1978: The distribution of the hydroxyl radical in the troposphere. Atmos. Sci. Paper 284 (Dept. of Atmos. Sci., Colorado State University, Fort. Collins, CO).

- A13. Crutzen, P.J. L.T. Gidel and J. Fishman, 1979: Numerical investigations of the photochemical and transport processes which affect ozone and other trace constituents in the atmosphere. Annual Summary of Research, Dept. of Atmospheric Science, Colorado State University, Fort Collins, CO.
- A14. Crutzen, P.J., 1981: Atmospheric chemical processes of the oxides of nitrogen including nitrous oxide. In: *Denitrification, Nitrification and Atmospheric Nitrous Oxide*. Ed. C.C. Delwiche, John Wiley and Sons, New York 1981, 17-44.
- A15. Birks, J.W. and P.J. Crutzen, 1983: Atmospheric effects of a nuclear war, *Chemistry in Britain*, **19**, 927-930.
- A16. Galbally, I.E., P.J. Crutzen and H. Rodhe, 1983: Some changes in the Atmosphere over Australia that may occur due to a Nuclear War, pp. 161-185 in "Australia and Nuclear War", (Ed. M.A. Denborough), Croom Helm Ltd., Canberra, Australia, 270 PP.
- A17. Brühl, C. and P.J. Crutzen, 1984: A radiative convective model to study the sensitivity of climate and chemical composition to a variety of human activities, Proceedings of a working party meeting, Brussels, 18th May 1984, Ed. A. Ghazi, CEC, pp. 84-94.
- A18. Crutzen, P.J. and M.O. Andreae, 1985: Atmospheric Chemistry, in T.F. Malone and J.G. Roederer, Eds., *Global Change*, Cambridge University Press, Cambridge, 75-1 13.
- A19. Crutzen, P.J. and I.E. Galbally, 1985: Atmospheric conditions after a nuclear war. In: *Chemical Events in the Atmosphere and Their Impact on the Environment*. (G.B. Marinetti-Bettolo, Editor), Pontificiae Academiae Scientiarum Scripta Varia, Città del Vaticano, pp. 457-502.
- A20. Crutzen, P.J. and J. Hahn, 1985: Atmosphärische Auswirkungen eines Atomkrieges. *Physik in unserer Zeit*, **16**, 4-15.
- A21. Klose, W., H. Butin, P.J. Crutzen, F. Führ, H. Greim, W. Haber, K. Hahlbrock, A. Hüttermann, W. Klein, W. Klug, H.U. Moosmayer, W. Obländer, B. Prinz, K.E. Rehfuess and O. Rentz, 1985: Forschungsbeirat Waldschäden/Luftverunreinigungen der Bundesregierung und der Länder, Zwischenbericht Dezember 1984, in *Bericht über den Stand der Erkenntnisse zur Ursache*
- A22. Crutzen, P.J., 1986: Globale Aspekte der atmosphärischen Chemie: Natürliche und anthropogene Einflüsse, Vorträge Rheinisch-Westfälische Akademie der Wissenschaften, S. 41-72, Westdeutscher Verlag GmbH, Opladen.
- A23. Klose, W., H. Butin and P.J. Crutzen, 1986: u.a. Forschungsbeirat Waldschäden/Luftverunreinigungen der Bundesregierung und der Länder, 2. Bericht, 229 S.
- A24. Crutzen, P.J., 1987: Recent depletions of ozone with emphasis on the polar "ozone hole". *Källa*, **28**, (Stockholm; in Swedish).
- A25. Crutzen, P.J., 1987: Climatic Effects of Nuclear War, Annex 2 in *Effects of Nuclear War on Health and Health Services*, Report A40/11 of the World Health Organization to the 40th World Health Assembly, 18 March 1987; WHO, Geneva.
- A26. Crutzen, P.J., 1987: Ozonloch und Spurengase-Menschliche Einflüsse auf Klima und Chemie der Atmosphäre, Max-Planck-Gesellschaft, Jahrbuch 1987, München, S. 27-40.
- A27. Darmstadter, J., L.W. Ayres, R.U. Ayres, W.C. Clark, R.P. Crosson, P.J. Crutzen, T.E. Graedel, R. McGill, J.F. Richards and J.A. Torr, 1987: Impacts of World Development on Selected Characteristics of the Atmosphere: An Integrative Approach, Oak Ridge National Laboratory, 2 Volumes, ORNL/Sub/8622033/1/V2, Oak Ridge, Tennessee 37931, USA.
- A28. Brühl, C. and P.J. Crutzen, 1989: The potential role of odd hydrogen in the ozone hole photochemistry, in *Our Changing Atmosphere* (P.J. Crutzen, J.-C. Gerard and R. Zander, Editors), Université de Liege, Institut d'Astrophysique, B-4200 Cointe-Ougree, Belgium, pp. 171-177.
- A29. Crutzen, P.J., W.M. Hao, M.H. Liu, J.M. Lobert and D. Scharffe, 1989: Emissions of CO<sub>2</sub> and other trace gases to the atmosphere from fires in the tropics, in P.J. Crutzen, J.C. Gerard and R. Zander, Eds.: *Our Changing Atmosphere*, Proceedings of the 28th Liege International Astrophysical Colloquium, Université de Liege, Belgium, pp. 449-471.

- A30. Graedel, T.E. and P.J. Crutzen, 1989: The Changing Atmosphere. *Scientific American*, pp. 58-68 (in deutsch: Veränderungen der Atmosphäre. *Spektrum der Wissenschaften*, pp. 58-68.
- A31. Lelieveld, J., P.J. Crutzen and H. Rodhe, 1989: Zonal average cloud characteristics for global atmospheric chemistry modelling. Report CM-76, UDC 551.510.4, Glomac 89/1. International Meteorological Institute in Stockholm, University of Stockholm, 54 pp.
- A32. Crutzen, P.J., 1990: Auswirkungen menschlicher Aktivitäten auf die Erdatmosphäre: Was zu forschen, was zu tun? *DLR-Nachrichten*, Heft 59, S. 5-13.
- A33. Crutzen, P.J., 1990: Comments on George Reid's "Quo Vadimus" contribution "Climate". In: Quo Vadimus. Geophysics for the next generation, Geophysical Monograph 60, IUGG Vol 10, Eds. G.D. Garland and John R. Apel, *American Geophysical Union*, Washington, USA, p. 47.
- A34. Crutzen, P.J., 1990: Global changes in tropospheric chemistry, *Proceedings of Summer School on Remote Sensing and the Earth's Environment*, Alpbach, Austria, 26 July-4 August 1989, pp. 105-113.
- A35. Crutzen, P.J., C. Briihl, 1990: The potential role of HO<sub>x</sub> and ClO<sub>x</sub> interactions in the ozone hole photochemistry, in *Dynamics, Transport and Photochemistry in the Middle Atmosphere of the Southern Hemisphere*, Ed. A. O'Neil, Kluwer, Dor-drecht, 203-212.
- A36. Crutzen, P.J. and C. Briihl, 1990: The atmospheric chemical effects of aircraft operations. In: *Air Traffic and the Environment-Background, Tendencies and Potential Global Atmosphere Effects. Proceedings of a DLR International Colloquium Bonn, Germany, November 15/16, 1990*, Ed. Schumann, Springer-Verlag, Heidelberg 1990, pp. 96-106.
- A37. Horowitz, A., G. von Helden, W. Schneider, F.G. Simon, P.J. Crutzen and G.K. Moortgat, 1990: Oxygen photolysis at 214 nm and 25 °C, *Proceedings of the Quadrennial Ozone Symposium*, Göttingen 8-13 August 1988, Eds. R.D. Boikov and P. Fabian, Deepak Publ. Co., pp. 690-693.
- A38. Briihl, Ch., P.J. Crutzen, E.F. Danielsen, H. Graßl, H.-D. Hollweg and D. Kley, 1991: Umweltverträglichkeitsstudie für das Raumtransportsystem SÄNGER, Teil 1 Unterstufe, Ed. Max-Planck-Institut für Meteorologie Hamburg, 142 pp.
- A39. Crutzen, P.J., 1991: Methane's sinks and sources. *Nature*, **350**, pp. 380-382.
- A40. Lelieveld, J. and P.J. Crutzen, 1991: Climate discussion and fossil fuels. *Oil Gas-European Magazine*, **4**, 11-15.
- A41. Crutzen, P.J., 1992: Ozone depletion: Ultraviolet on the increase. *Nature*, **356**, 104-105.
- A42. Crutzen, P.J., 1992: Menschliche Einflüsse auf das Klima und die Chemie der globalen Atmosphäre, in: *Stadtwerke der Zukunft-ASEW-Fachtagung Kassel, 1991*, Ed. ASECW, Köln, Ponte Press, Bochum, 7-27.
- A43. Graedel T.E. and P.J. Crutzen, 1992: Ensemble assessments of atmospheric emissions and impacts, in: *Energy and the Environment in the 21<sup>st</sup> Century*, pp 1-24, Energy Laboratory, Massachusetts Institute of Technology, Cambridge.
- A44. Sander, R., J. Lelieveld and P.J. Crutzen, 1992: Model calculations of the nighttime aqueous phase oxidation of S(IV) in an orographic cloud. Proceedings of Joint CEC/EUROTRAC Workshop and LACTOZ-HALIPP Working Group on *Chemical Mechanisms Describing Tropospheric Processes*, Leuven, Belgium, September 23-25, 1992, Air Pollution Research Report 45, Ed. J. Peeters, E. Guyot SA, Brussels, 285-290.
- A45. Briihl, Ch., P.J. Crutzen, H. Graßl and D. Kley, 1993: The impact of the spacecraft system SÄnger on the composition of the middle atmosphere, in: *AZAA Fourth International Aerospace Planes Conference*, Orlando/Florida, 1-4 December 1992, American Institute of Aeronautics and Astronautics, Washington DC, 1-9.
- A46. Crutzen, P.J., 1993: Die Beobachtung atmosphärisch-chemischer Veränderungen: Ursachen und Folgen für Umwelt und Klima. In: *Klima: Vorträge im Wintersemester 1992/93*, Sammelband der Vorträge des Studium Generale der Ruprecht-Karls-Universität Heidelberg (Ed.), Heidelberger Verlagsanstalt, 31-48.

- A47. Grooß, J.U., Th. Peter, C. Brühl and P.J. Crutzen, 1994: The influence of high flying aircraft on polar heterogeneous chemistry, Proceedings of an International Scientific Colloquium on *Impart of Emissions from Aircraft and Spacecraft upon the Atmosphere*, Köln, Germany, April 18-20, 1994, DLR-Mitteilung 9406, U. Schumann and D. Wurzel (Eds.), 229-234.
- A48. Kanakidou, M., P.J. Crutzen and P.H. Zimmermann, 1994: Estimates of the changes in tropospheric chemistry which result from human activity and their dependence on NO<sub>x</sub> emissions and model resolution, *Proceedings of the Quadrennial Ozone Symposium*, June 4-13, 1992, Charlottesville, Virginia, U.S., NASA Conference Publication 3266, 66-69
- A49. Müller, R. and P.J. Crutzen, 1994: On the relevance of the methane oxidation cycle to "ozone hole chemistry", *Proceedings of the Quadrennial Ozone Symposium*, June 4-13, 1992, Charlottesville, Virginia, U.S., NASA Conference Publication 3266, 298-301.
- A50. Peter, Th. and P.J. Crutzen, 1994: Das Ozonloch: Wie kam es dazu und was sollten wir daraus lernen? In: *Der Mensch im Strahlungsfeld der Sonne. Konstanz und Wandel in Natur und Gesellschaft*. Ed. C. Fröhlich, FORUM DAVOS, Wissenschaftliches Studienzentrum, Davos, 31-44.
- A51. Steil, B., C. Brühl, P.J. Crutzen, M. Dameris, M. Ponater, R. Sausen, E. Roeckner, U. Schlese and G.J. Roelofs, 1994: A chemistry model for use in comprehensive climate models, Proceedings of an International Scientific Colloquium on *Impart of Emissions from Aircraft and Spacecraft upon the Atmosphere*, Köln, Germany, April 18-20, 1994, DLR-Mitteilung 9406, U. Schumann and D. Wurzel (Eds.), 235-240.
- A52. Andreae, M.O., W.R. Cofer 111, P.J. Crutzen, P.V. Hobbs, J.M. Hollander, T. Kuhlbusch, R. Novakov, J.E. Penner, 1995: Climate impacts of carbonaceous and other non-sulfate aerosols: A proposed study. Lawrence Berkely Laboratory Document-PUB-54 11.
- A53. Crutzen, P.J., 1995: On the role of ozone in atmospheric chemistry. In: "The Chemistry of the Atmosphere. Oxidants and Oxidation in the Earth's Atmosphere", Proceedings of the 7th BOC Priestley Conference, Lewisburg, Pennsylvania, U.S.A., June 25-27, 1994, Ed. A.R. Bandy, The Royal Society of Chemistry, Cambridge, UK, 3-36.

## IN PRESS

- A54. Lelieveld, J., P.J. Crutzen, D. Jacob and A. Thompson, 1995: modeling of biomass burning influences on tropospheric ozone, SAFARI BOOK
- A55. Kanakidou, M., F.J. Dentener and P.J. Crutzen: Chlorodifluoromethane (HCFC-22) and its oxidation products in the troposphere. *Proceedings of the 3rd Conference on Environmental Science and Technology*, September 6-9, 1993, Lesvos, Greece.

*Address:* Max-Planck-Institute for Chemistry  
(office) Department of Atmospheric Chemistry  
P.O. Box 3060  
D-55020 Mainz/GERMANY  
Telephone: +49-(O) 6131-305-458/9  
Telefax: +49-(O) 6131-305-511 (or 436)  
E-mail: [air@mpch-mainz.mpg.d400.de](mailto:air@mpch-mainz.mpg.d400.de)

(privat) Am Fort Gonsenheim 36  
55122 Mainz  
Telephone: +49-(O) 6131-381094