

ALBERT A. MICHELSON

Recent advances in spectroscopy

Nobel Lecture, December 12, 1907

The fame of Newton rests chiefly on his epoch-making discovery of the laws of gravitational astronomy - by means of which the position of the moons, the planets, and the comets, and other members of our solar system can be calculated and verified with the utmost precision - and in many cases such calculation and verification may be extended to systems of suns and planets outside our own.

But in no less degree are we indebted to this monumental genius for that equally important branch of Astrophysics - in which the spectroscope plays so fundamental a role - by means of which we are enabled to discover the physical and chemical constitution of the heavenly bodies, as well as their positions and motions. As the number and intricacy of the wonderful systems of stellar worlds which the telescope can reveal increase with its power, so also do the evidences of the innermost molecular structure of matter increase with the power of the spectroscope. If Newton's fundamental experiment of separating the colors of sunlight had been made under conditions so slightly different from those in his actual experiment that in the present stage of experimental science, they would at once suggest themselves to the veriest tyro - the science of spectroscopy would have been founded.

So simple a matter as the narrowing of the aperture through which the sunlight streamed before it fell upon the prism which separates it into its constituent colors - would have sufficed to show that the spectrum was crossed by dark lines, named after their discoverer, the Fraunhofer lines of the Solar Spectrum. These may be readily enough observed, with no other appliances than a slit in a shutter which is observed through an ordinary prism of glass. Fraunhofer increased the power of the combination enormously by observing with a telescope - and this simple combination, omitting minor details, constitutes that wonder of modern science, the Spectroscope. As the power of a telescope is measured by the closeness of the double stars which it can "resolve", so that of the Spectroscope may be estimated by the closeness of the spectral lines which it can separate. In order to form an idea of the advance in the power of spectroscopes

let us for a moment consider the map of the Solar Spectrum (Figure 1).

The portion which is visible to the unaided eye extends from the Fraunhofer line A to H; but by photography it may be traced far into the ultra-violet region and by bolometric measurements it is found to extend enormously farther in the region beyond the red. In the yellow we observe a dark line marked *D*, which coincides in position with the bright light emitted by sodium - as when salt is placed in an alcohol flame. It may be readily shown by a prism of very moderate power that this line is double, and as the power of the instrument increases the distance apart or separation of this doublet furnishes a very convenient measure of its separating or resolving power. Of course this separation may be effected by simple magnification, but this would in itself be of no service, as the "lines" themselves would be broadened by the magnification in the same proportion. It can be shown that the effective resolving power depends on the material of the prism which must be as highly dispersive as possible and on the size, or number, of the prisms employed - and by increasing these it has been found possible to "resolve" double lines thirty or forty times as near together as are the sodium lines. It will be convenient to take the measure of the resolving power when just sufficient to separate the sodium lines as 1,000. Then the limit of resolving power of prism spectroscopes may be said not much to exceed 40,000.*

This value of resolving power is found in practice to obtain under average conditions. Theoretically there is no limit save that imposed by the optical conditions to be fulfilled - and especially by the difficulty in obtaining large masses of the refracting material of sufficient homogeneity and high dispersive power. It is very likely that this limit has not yet been reached.

Meanwhile another device for analysing light into its component parts has been found by Fraunhofer (1821) which at present has practically superseded the prism - namely, the diffraction grating. Fraunhofer's original grating consisted of a number of fine equidistant wires, but he afterwards made them by ruling fine lines on a glass plate covered with gold leaf and removing the alternate strips. They are now made by ruling upon a glass or a metal surface fine equidistant lines with a diamond point.

The separation of light into its elements by a grating depends on its action on the constituent light-waves.

Let Fig. 2 represent a highly magnified cross section of a diffraction grating with plane waves of light falling upon it normally, as indicated by the ar-

* Lord Rayleigh has obtained results with prism of carbon disulphide which promise a much higher resolving power.

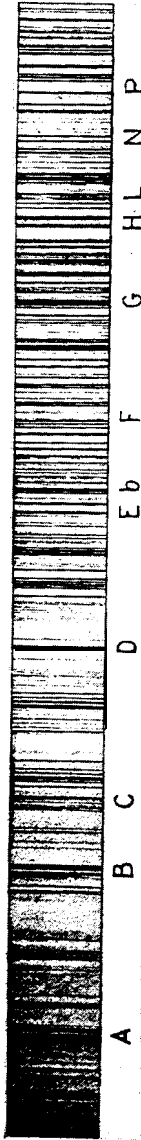

Fig.1.

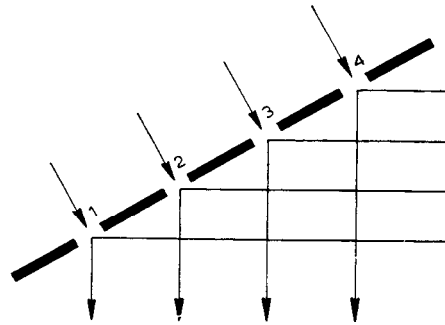

Fig.2.

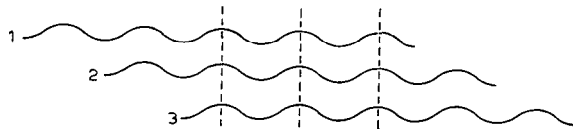

Fig. 3.

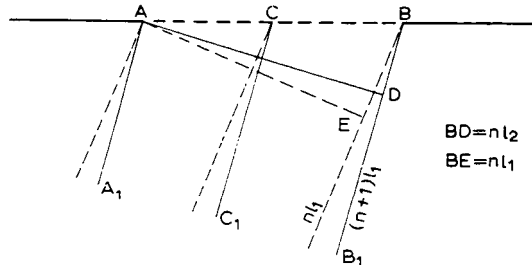

Fig. 4.

rows. The wave motion will pass through the apertures, and will continue as a series of plane waves; and if brought to a focus by a telescope will produce an image of the slit source just as if no grating were present (save that it is fainter, as some of the light is cut off by the opaque portions). This image may be considered as produced by the concurrence of all the elementary waves from the separate apertures meeting in the same phase of vibration, thus re-enforcing each other. But this may also be true in an oblique direction, as shown in the figure, if the retardation of the successive waves is just one whole wavelength (or any whole number) as is illustrated in Fig. 3, where the successive waves from apertures 1, 2, 3 ... are shown to re-enforce each other just as if they all belong to a single wave-train. In this direction therefore there will also be an image of the slit source; and this direction is determined by the relation:

$$\sin \theta = \frac{m l}{s}$$

where l is the length of the light-wave of this particular color, s the distance between the apertures (the grating space), and m the number of waves in the common retardation (1,2,3, etc.). But even if the light thus diffracted be absolutely homogeneous (that is, consist of an infinite wave-train of constant wavelength) it does not follow that the light is all diffracted in the given direction; there will be some light in directions differing slightly from this - growing less until the extreme difference of path is (say) $n + 1$ waves, (instead of n when it is ml).

In fact, if we divide the pencil having this new direction into two equal parts AC and CB , the ray AA , will be $n + 1/2$ waves in advance of CC , and the two will be in opposite phases of vibration, and will therefore neutralize each other. The same will be true of each pair of rays taken in the same manner over the whole grating space, and the result is total darkness for this direction. Let us suppose we are examining the double sodium line. The difference between the components is about one thousandth of the wavelength. With a grating of n lines there will be total darkness in a direction corresponding to a retardation of $(n + 1) l$. Let this direction correspond to the brightest part of the image for the second sodium line 1_2 so that $(n + 1) l = n 1_2$ or $(1_2 - 1_1)/s = l/n$. Under these conditions the two images are just <<resolved>>. But $(1_2 - 1_1)/l = l/1,000$ for sodium lines, whence $n = 1,000$. That is, a grating of 1,000 lines will "resolve" the sodium lines in the first spectrum, or $R = 1,000$. In the second (where the common retardation

is two wavelengths) the resolving power is twice as great or $2n$, and in the m th spectrum, m times as great. The resolving power is therefore the product of the number of lines in the grating by the order of the spectrum, that is, $R = mn$.

In order, therefore, to obtain high resolving power the grating must have a great number of rulings and if possible a high order of spectrum should be used. The rulings need not be exceedingly close together, but it is found practically sufficient if there are from 500 to 1,000 lines per millimeter. The earlier gratings were relatively small and contained only a few thousand lines. The best of these were ruled by Nobert (1851). A very great advance was made by Rutherford of New York, who (1868) ruled gratings two inches long on speculum metal and containing about 20,000 lines. These gratings exceeded in resolving power the best prism trains in use at the time. The next advance was made by Rowland of the Johns Hopkins University, who succeeded in ruling gratings six inches long (by two to three inches stroke) having about one hundred thousand lines, and capable (theoretically, at least) of resolving in the spectrum, double lines whose distance apart was only one one-hundredth as great as that of the sodium lines. Practically this is about the limit of the power of the best Rowland grating which I have examined.

The difference between the theoretical and the actual performance is due to want of absolute uniformity in the grating space. This is due to the enormous difficulty in constructing a screw which shall be practically perfect throughout its whole length, a difficulty which increases very rapidly as the length of the screw increases; and it has been supposed that the limit of accuracy was reached in these gratings.

The great and rapidly increasing importance of spectrum analysis - especially in determining the distribution of light in so-called spectral lines under normal conditions, the resolution of complicated systems of lines, and in the investigation of the effects of temperature, of pressure, and especially of a magnetic field - justified the undertaking of much larger gratings than these. As an example of progress made in this direction, I have the honor of exhibiting a grating having a ruled surface nine inches long by four and one half inches stroke (220 x 110mm). This has one hundred and ten thousand lines and is nearly perfect in the second order; so that its resolving power is theoretically 220,000 and this is very nearly realized in actual experiments.

It will be observed that the effect produced at the focus of the telescope depends on the concurrence or opposition - in general on the *interference* of

the elementary trains of light-waves. We are again indebted to the genius of Newton for the first observation of such interference; and a comparatively slight modification of the celebrated experiment of "Newton's rings" leads to a third method of spectrum analysis which, if more indirect and less convenient than the methods just described, is far more powerful. If two plane surfaces (say the inner surfaces of two glass plates) are adjusted very accurately to parallelism, and sodium light fall on the combination at nearly normal incidence, the light reflected from the two surfaces will interfere, showing a series of concentric rings alternately bright and dark, according to the relative retardation of the two reflected light beams.

If this retardation changes (by slowly increasing the distance between the surfaces) the center of the ring system goes through alternations of light and darkness, the number of these alternations corresponding exactly to the number of light-waves in twice the increase in distance. Hence the measurement of the length of the waves of any monochromatic light may be obtained by counting the number of such alternations in a given distance. Such measurement of wavelengths constitutes one of the most important objects of spectroscopic research.

Another object accomplished by such measurement is the establishment of a natural standard of length in place of the arbitrary standard at present in use - the meter. Originally it was intended this should be the ten-millionth part of an earth-quadrant, but it was found that the results of measurements differed so much that this definition was abandoned. The proposition to make the ultimate standard the length of a pendulum which vibrates seconds at Paris met with a similar fate.

Shortly after the excellent gratings made by Rutherford appeared, it was proposed (by Dr. B. A. Gould) to make the length of a wave of sodium light the ultimate standard; but this idea was never carried out. It can be shown that it also is not susceptible of the requisite degree of accuracy, and in fact a number of measurements made with a Rowland grating have been shown to be in error by about one part in thirty thousand. But modern conditions require a much higher degree of accuracy. In fact, it is doubtful if any natural standard could replace the arbitrary standard meter, unless it can be shown that it admits of realization in the shape of a material standard which can not be distinguished from the original.

One of the most serious difficulties encountered in the attempt to carry into practice the method of counting the alternations of light and darkness in the interference method, is the defect in homogeneity of the light em-

ployed. This causes indistinctness of the interference rings when the distance is greater than a few centimeters. The light emitted by various kinds of gases and metallic vapors, when made luminous by the electric discharge, differ enormously in this respect. A systematic search showed that among some forty or more radiations nearly all were defective, some being represented by a spectrum of broad hazy "lines", others being double, triple, or even more highly complex. But the red light emitted by luminous vapor of metallic cadmium was found to be almost ideally adapted for the purpose. Accordingly this was employed: and the results of three independent measurements, made by different observers and at different times, of the number of light-waves of red cadmium light in the standard meter are as follows:

I	1,553,392.4
II	1,553,393.2
III	1,553,393.4.

It will be seen that the differences are less than half a millionth part, and this is about the limit of accuracy of the comparative measurements of the material standards. Within the last year a similar determination has been carried out by Perot and Fabry, with a result not to be distinguished from the above. It follows that we now have a natural standard of length, the length of a light-wave of incandescent cadmium vapor; by means of which a material standard can be realized, whose length can not be distinguished from the actual standard meter - so that if, through accident or in time, the actual standard meter should alter, or if it were lost or destroyed, it could be replaced so accurately that the difference could not be observed.

In the search for a radiation sufficiently homogeneous for the purpose of a standard it became evident that the interference method might be made to yield information concerning the distribution of light in an approximately homogeneous source when such observations would be entirely beyond the power of the best spectroscopes. To illustrate, suppose this source to be again the double radiation from sodium vapor. As the wavelengths of these two radiations differ by about one part in a thousand, then at a difference of path of five hundred waves (about 0.36 mm) the bright fringes of one wave-train would cover the dark fringes of the other, so that if the two radiations were of equal intensity, all traces of interference would vanish. At twice this distance they would reappear and so on indefinitely, if the separate radiations were absolutely homogeneous. As this is not the case, however, there would

be a gradual falling off in the clearness or visibility of the bands. Inversely, if such changes are observed in actual experiment, we infer that we are dealing with a double source. Further, from the distance between the maxima of distinctness, we may determine (and with extraordinary accuracy) the ratio of wavelenghts of the components; from the ratio of maxima to minima we may infer the ratio of their intensities; and finally the gradual falling off when the distance becomes large gives accurate information of the "width" of the corresponding spectral lines.

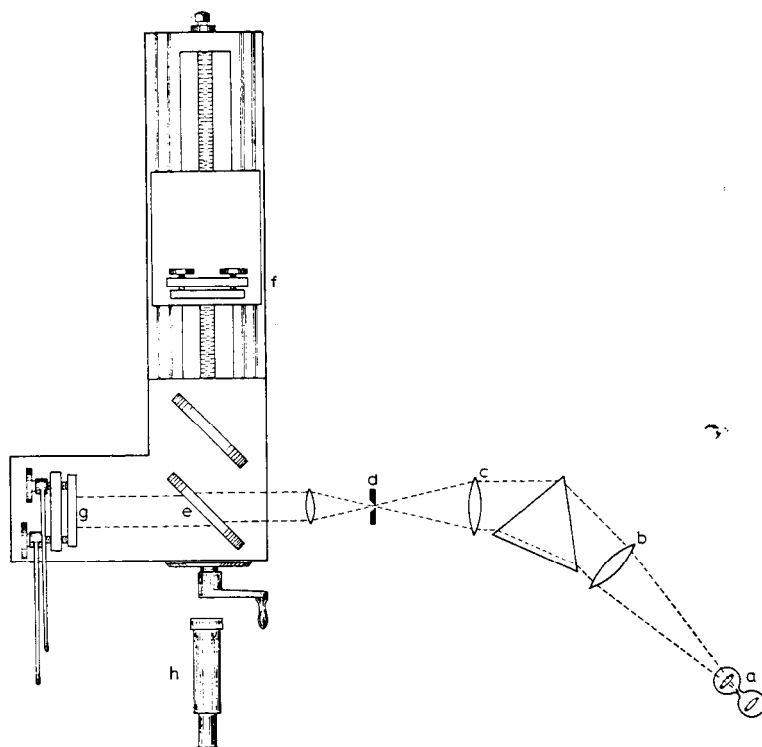

Fig. 5.

In this way it was found that the red line of hydrogen is a double with components about one fortieth of the distance apart of the sodium lines. Thallium has a brilliant green radiation which is also double, the distance being one sixtieth that of the sodium lines. Mercury shows a brilliant green line, which is highly complex, but whose chief component is a doublet, whose separation is only one seven-hundredth of that of sodium. The inter-

ference fringes are still visible when the difference of path is of the order of five hundred millimeters, corresponding to over a million light-waves; and the corresponding width of spectral line would be less than a thousandth part of that which separates the sodium lines.

Fig. 5 illustrates the arrangement of the apparatus as it is actually used. An ordinary prism spectroscope gives a preliminary analysis of the light from the source. This is necessary because the spectra of most substances consist of numerous lines. For example, the spectrum of mercury contains two yellow lines, a very brilliant green line, and a less brilliant violet line, so that if we pass all the light together into the interferometer, we have a combination of all four. It is usually better to separate the various radiations before they enter the interferometer. Accordingly, the light from the vacuum tube at *a* passes through an ordinary spectroscope *b c*, and the light from only one of the lines in the spectrum thus formed is allowed to pass through the slit *d* into the interferometer.

As explained above, the light divides at the plate *e*, part going to the mirror *f*, which is movable, and part passing through, to the mirror *g*. The first ray returns on the path *f e h*. The second returns to *e*, is reflected, and passes into the telescope *h*.

The resolving power of the interferometer is measured by the number of light-waves in the difference of path of the two interfering pencils, and as this is unlimited, the interferometer furnishes the most powerful means for investigating the structure of spectral lines or groups. Its use is, however, somewhat handicapped by the fact that the examination of a single group of lines may require a considerable number of observations which take some time and during which it may be difficult to prevent changes in the light source. Nevertheless it was found possible by its means to investigate the wonderful discovery of Zeeman - of the effect of a magnetic field on the character of the radiation from a source subjected to its influence; and the results thus obtained have been since confirmed by methods which have been subsequently devised.

One of these is the application of the echelon. This is in effect a diffraction grating in which high resolving power is obtained by using a very high order of spectrum into which practically all, the light is concentrated. The number of elements may be quite moderate - since the resolving power is the product of the two. The order of the spectrum is the number of wavelengths in the retardation at each step. This retardation (which must be very accurately constant) is secured by allowing the incident light to fall upon a

pile of glass plates optically plane parallel and of the same thickness - each one a little wider than the preceding as in Fig.6.

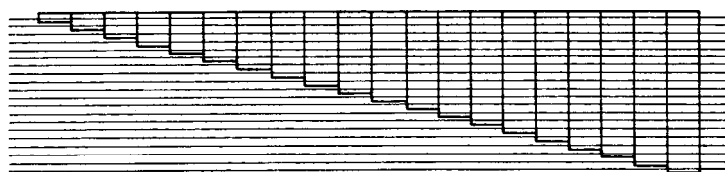

Fig.6.

Thus if the pile has forty plates, each one centimeter thick, the retardation will be about ten thousand light-waves; and the resolving power would be forty times this or four hundred thousand - which is about four times as that of a six-inch diffraction grating of the usual form. The number of elements might be increased till the absorption of the glass brought a limit. A difficulty, which appears long before this limit is reached, is due to the loss of light by repeated reflections between the many surfaces. This has been very ingeniously overcome by Mr. Twyman of the firm of Hilger & Company by pressing the plates together to actual contact - when the reflection vanishes. It is likely that the echelon under these conditions may be used by reflection instead of transmission (the plates being silvered for the purpose) with the advantage of quadrupling the resolving power for the same number of plates and eliminating the absorption.

An illustration of the efficiency of the echelon spectrograph is furnished by the following photographs of the spectrum of green radiations from mercury vapor. The first of the figures shows the spectrum of the second order of a diffraction grating whose ruled surface is nine inches by four and a half - the largest in existence. The second is by an echelon of thirty plates, seven millimeters thick, and in the third the echelon consisted of forty plates, each an inch and a fourth thick (30 mm). The corresponding lines are similarly lettered in the three figures. The scale is in Å.U.(Ångstrom units). It will be noted in the last of the three figures that the width of the fainter companion is about one one-hundredth of an Å.U. The limit of resolution of the instrument is about half as much, or its resolving power is over a million (Figs. 7, 8 and 9).

It will be observed that the echelon spectra are repeated - thus a_1 and a_2 are two successive spectra of the same line. This is true of any grating spectrum, and the difficulties which arise from the overlapping of the suc-

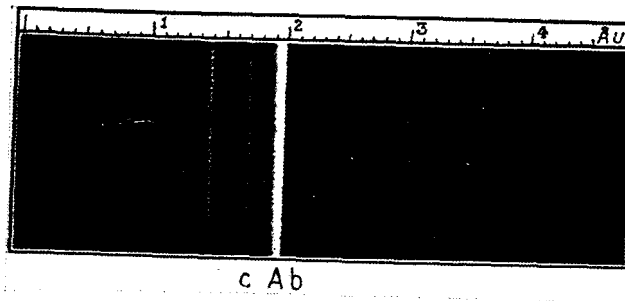

Fig.7.

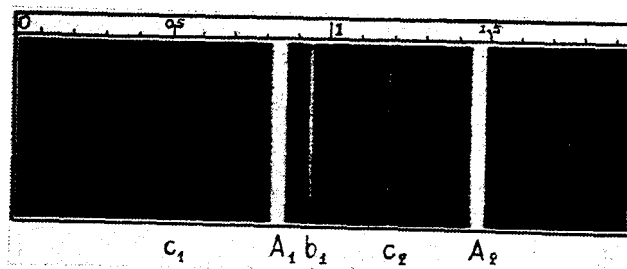

Fig.8.

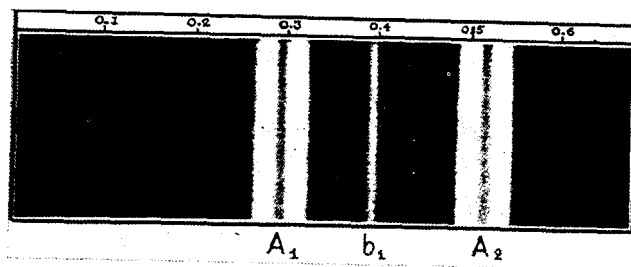

Fig.9.

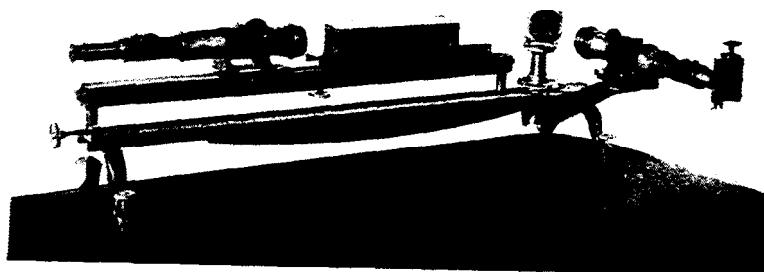

Fig.10.

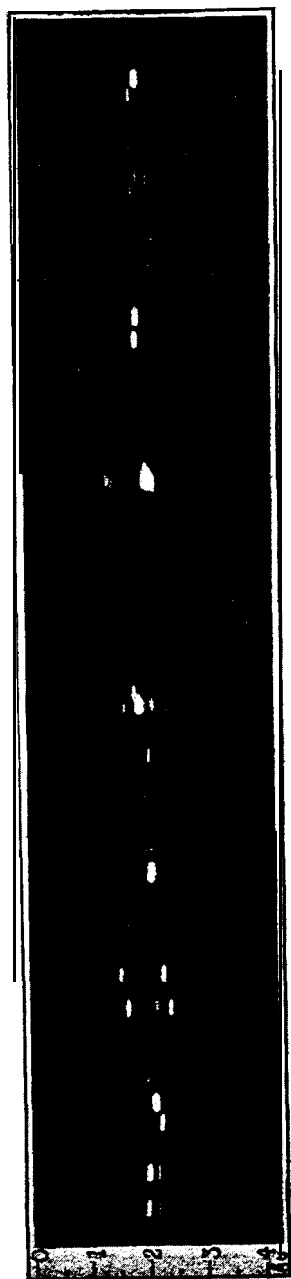

Fig.11.

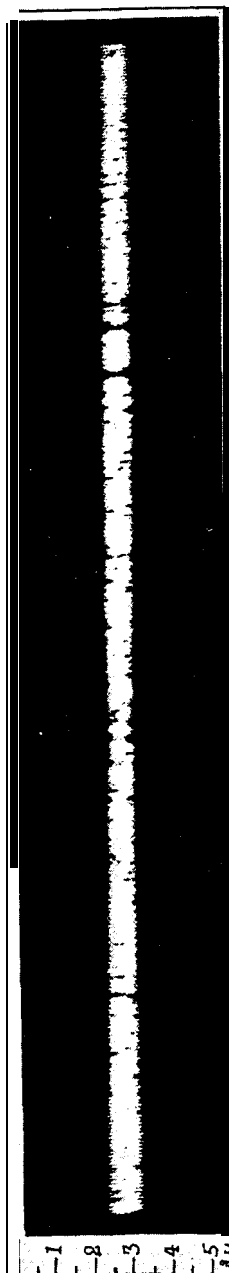

Fig.12.

cessive orders of spectrum may be overcome by separating these by a prism whose refracting edge is perpendicular to the lines of the grating. The same is true of the echelon spectrum - save that the order of the overlapping spectra is so high that a prism is hardly adequate and recourse must be had to a grating - with its plane of diffraction perpendicular to that of the echelon, as shown in Fig. 10.

With this arrangement it is possible to photograph a large part of the spectrum at once.*

Fig. 11 shows such a photograph of the iron spectrum, and it may be noted that this combination of grating and echelon makes it possible to observe absorption spectra as well as bright line spectra.

Fig. 12 shows a photograph of the solar spectrum taken in this way. It will be noted that the spectral "lines" are generally too broad to justify the use of so great a resolving power.

Finally it may be pointed out that this combination gives us the means of comparing the wavelengths of spectral lines with a degree of accuracy far superior to that of the grating.

* If the preliminary analysis has been made before the light entered the slit of echelon spectroscopy, it would be possible to examine but one - at most a few - lines at a time.